

METALMASTER

OPERATION MANUAL



HYDRAULIC NC GUILLOTINE

E21S CONTROLLER

Models.

HG-2504, HG-2506, HG-3206, HG-3212, HG-4006, HG-4012

Order Codes S934, S937, S940, S942, S946, S948

Edition No : SBG002

Date of Issue : 03/2020

www.machineryhouse.com.au

MACHINE DETAILS**MACHINE**

HYDRAULIC NC GUILLOTINE

MODEL NO.**SERIAL NO.****DATE OF MANF.**

DISTRIBUTED BY

www.machineryhouse.com.auwww.machineryhouse.co.nz**Note:**

This manual is only for your reference. Owing to the continuous improvement of the Metalmaster machine, changes may be made at any time without obligation or notice. Please ensure the local voltage is the same as listed on the specification plate before using this electric machine.

**NOTE:**

In order to see the type and model of the machine, please see the specification plate. Usually found on the back of the machine. See example (Fig.1)

An example of a product specification plate. It features the Metalmaster logo at the top, followed by the text "PRODUCT SPECIFICATION". Below this are several fields for machine details: MODEL, CAPACITY, SER. NO., MFG DATE, WEIGHT, VOLTS, and MOTOR Kw. Each field is followed by a rectangular input box. At the bottom of the plate, the website www.machineryhouse.com.au and "Made in China" are printed.

METALMASTER	
PRODUCT SPECIFICATION	
MODEL:	<input type="text"/>
CAPACITY:	<input type="text"/>
SER. NO:	<input type="text"/>
MFG DATE:	<input type="text"/>
WEIGHT:	<input type="text"/>
VOLTS:	<input type="text"/>
MOTOR Kw:	<input type="text"/>
www.machineryhouse.com.au Made in China	

FIG.1

C O N T E N T S:

1. GENERAL MACHINE INFORMATION	
1.1 Specifications.....	4
1.2 Standard Equipment.....	4
1.3 Overall Drawings.....	5
1.4 Identification.....	6
2. IMPORTANT INFORMATION	
2.1 General Metalworking Machine Safety.....	7
2.2 Safety Procedure for Guillotines.....	10
2.3 Lifting Instructions.....	11
3. SETUP	
3.1 Clean-Up.....	12
3.2 Site Preparation.....	12
3.3 Base Foundation and Securing Points.....	13
3.4 Electrical Installation.....	14
3.5 Full Load Current Rating.....	14
3.6 Checking the Power Supply.....	15
3.7 Machine Leveling.....	15
3.8 Attaching the Accessories.....	16
3.9 Fill the Hydraulic Oil Tank.....	17
4. COMMISSIONING	
4.1 Preparation of the Machine.....	18
4.2 Controls.....	18
4.3 Omrom E3Z Safety Sensor Alignment.....	20
5. OPERATION INSTRUCTION	
5.1 Starting The Machine For The First Time.....	23
5.2 Pre-Operational Safety Check Prior to Operating...	24
5.3 Testing The Emergency Stops.....	25
5.4 E21S Guillotine Calibration: X Axis.....	26
5.5 Estun E21S Guillotine Controller Operation.....	27
5.6 Setting the Blade Gap.....	29
6. MAINTENANCE	
6.1 Type and frequency of Inspections.....	30
6.2 Lubrication Points.....	31
6.3 Changing The Hydraulic Oil.....	32
6.4 Changing The Filter.....	33
6.5 Blade Parallel Adjustment.....	34
6.6 Maintaining the Back Gauge.....	35
6.7 Back Gauge Parallel Adjustment.....	36
6.8 Troubleshooting.....	37
APPENDIX	
Wiring Diagrams.....	38
Risk Assessment.....	46
E21S Manual.....	49

1.1 SPECIFICATIONS:

Order Code	S934	S937	S940	S942	S946	S948
MACHINE TYPE	HG-2504	HG-2506	HG-3206	HG-3212	HG-4006	HG-4012
Shearing Length (mm)	2500	2500	3200	3200	4000	4000
Material Capacity Mild Steel (mm)	4	6	6	12	6	12
Material Capacity Stainless Steel (mm)	2.5	4	4	8	4	8
Shear Angle (degree)	1.5	1.5	1.5	1.5	1.5	1.5
Back Gauge Range (mm)	900	1000	1000	1000	1000	1000
System Pressure	18	18	18	18	18	18
Oil Tank Volume	150	170	205	300	205	420
Dimensions Width (mm)	3130	3130	3840	3925	4630	4735
Depth (mm)	1530	1530	1675	1800	1800	2000
Height (mm)	1600	1600	1620	1940	1700	2040
Height of Work Table (mm)	740	800	800	800	800	860
Weight (kgs)	4000	5280	7100	11000	8860	13500
Main Motor 3 Phase 415 V 50Hz (kW)	4	7.5	7.5	18.5	7.5	18.5
Back Gauge 3 Phase 415 V 50 Hz (kW)	0.55	0.55	0.55	0.55	0.55	0.55

1.2. STANDARD EQUIPMENT:

- Back-gauge assembly
- Rear guarding
- Foot switch and control panel
- Front sheet supports
- Toolset and Instruction manual

1.3. OVERALL DRAWINGS

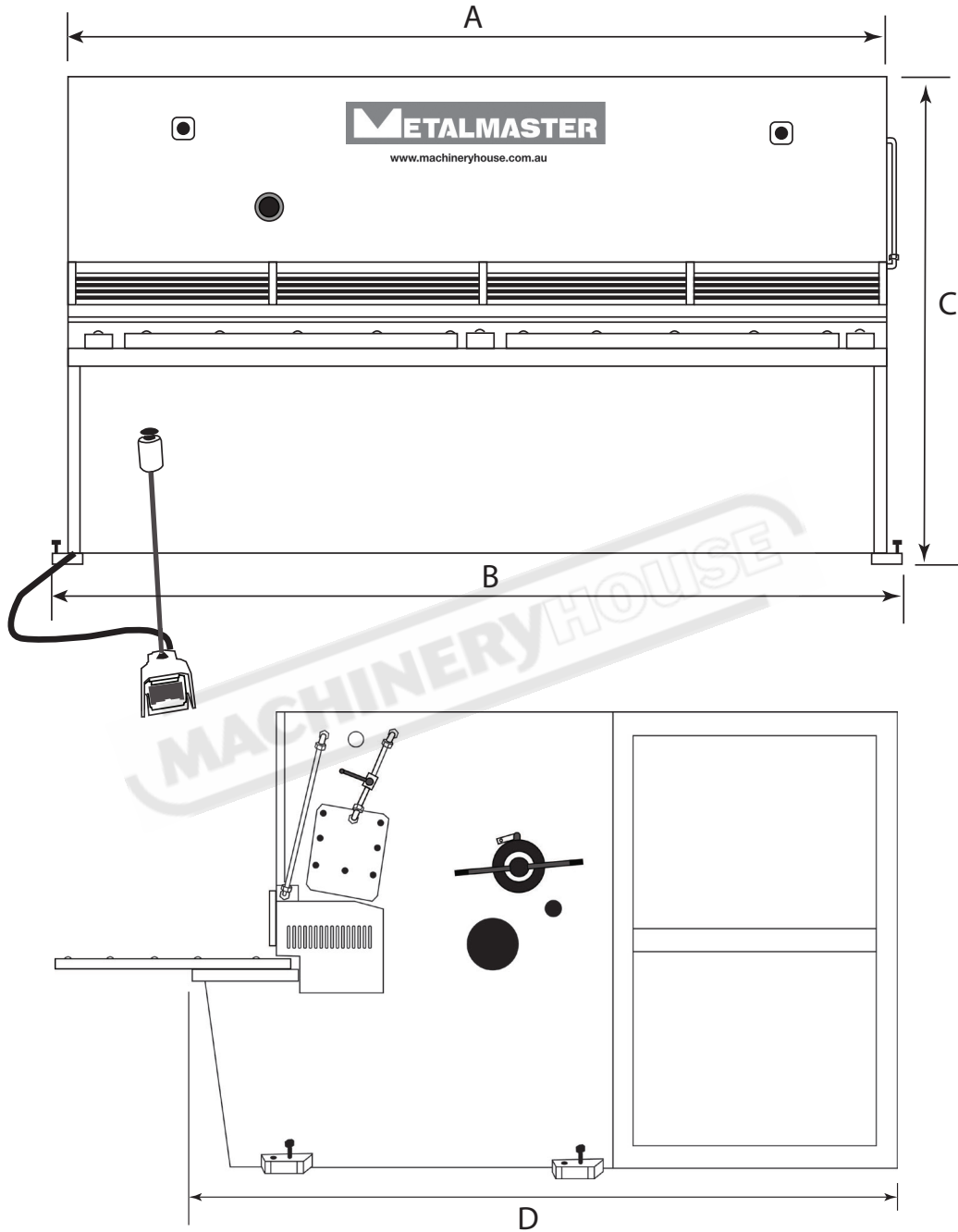

mm	HG-2504	HG-2506	HG-3206	HG-3212	HG-4006	HG-4012
A	3130	3130	3840	3925	4630	4735
B	3230	3230	3990	4175	4830	4935
C	1600	1600	1620	1940	1700	2040
D	2530	2530	2675	2800	2800	3000

1.4 IDENTIFICATION

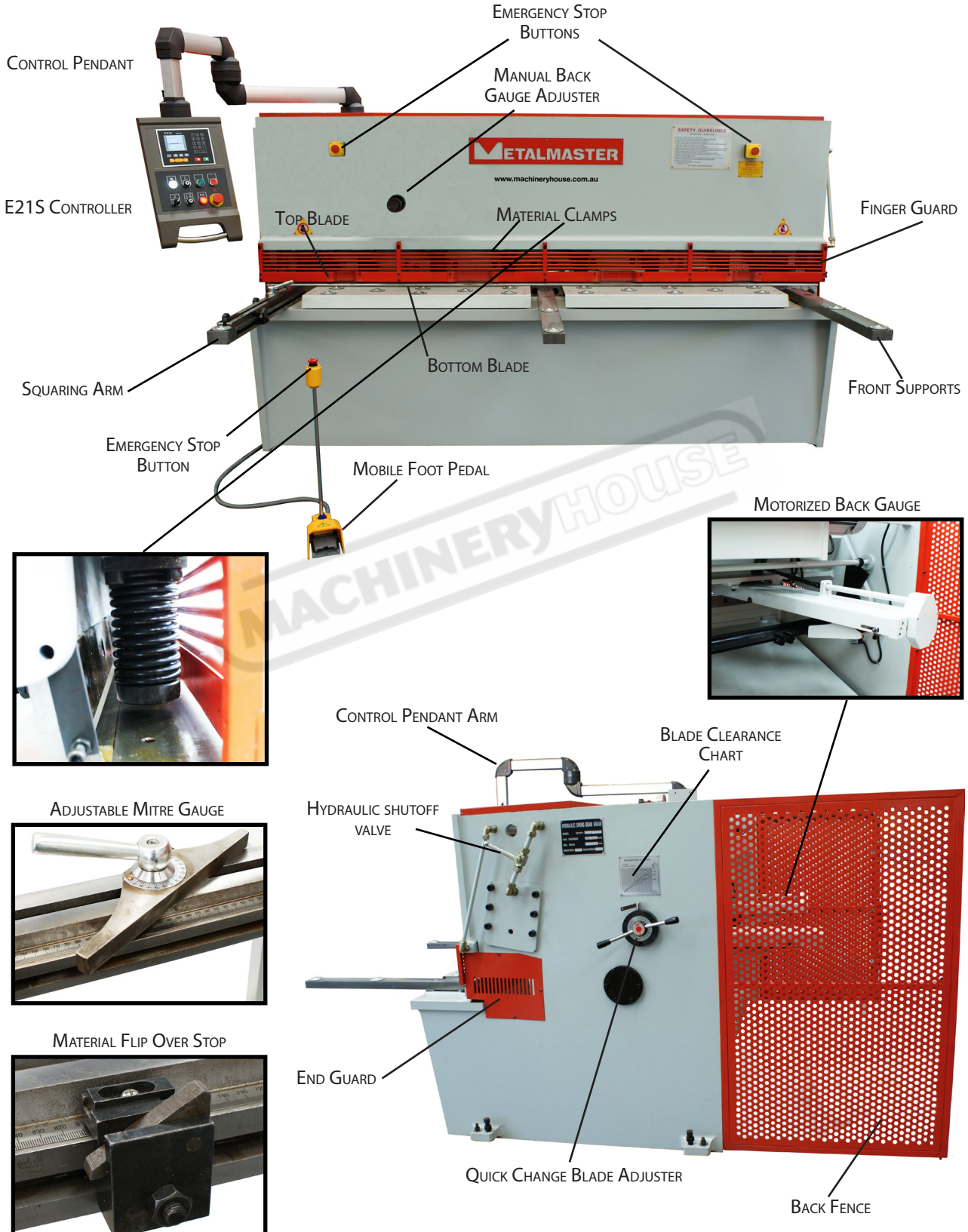

2.1 GENERAL METALWORKING MACHINE SAFETY

DO NOT use this machine unless you have read this manual or have been instructed in the use of this machine in its safe use and operation



WARNING

This manual provides safety instructions on the proper setup, operation, maintenance, and service of this machine. Save this manual, refer to it often, and use it to instruct other operators. Failure to read, understand and follow the instructions in this manual may result in fire or serious personal injury—including amputation, electrocution, or death.

The owner of this machine is solely responsible for its safe use. This responsibility includes, but is not limited to proper installation in a safe environment, personnel training and authorization to use, proper inspection and maintenance, manual availability and comprehension, of the application of the safety devices, integrity, and the use of personal protective equipment.

The manufacturer will not be held liable for injury or property damage from negligence, improper training, machine modifications or misuse.



- ✓ Always wear safety glasses or goggles.
- ✓ Wear appropriate safety footwear.
- ✓ Wear respiratory protection where required.
- ✓ Gloves should never be worn while operating the machine, and only worn when handling the workpiece.
- ✓ Wear hearing protection in areas > 85 dBA. If you have trouble hearing someone speak from one metre (three feet) away, the noise level from the machine may be hazardous.
- ✓ DISCONNECTION THE MACHINE FROM POWER when making adjustments or servicing.
- ✓ Check and adjust all safety devices before each job.
- ✓ Ensure that guards are in position and in good working condition before operating.
- ✓ Ensure that all stationary equipment is anchored securely to the floor.
- ✓ Ensure all machines have a start/stop button within easy reach of the operator.
- ✓ Each machine should have only one operator at a time. However, everyone should know how to stop the machine in an emergency.

2.1 GENERAL METALWORKING MACHINE SAFETY Cont.

- ✓ Ensure that keys and adjusting wrenches have been removed from the machine before turning on the power. Appropriate storage for tooling should be provided.
- ✓ Ensure that all cutting tools and blades are clean and sharp. They should be able to cut freely without being forced.
- ✓ Stop the machine before measuring, cleaning or making any adjustments.
- ✓ Wait until the machine has stopped running to clear cuttings with a vacuum, brush or rake.
- ✓ Keep hands away from the cutting head and all moving parts.
- ✓ Avoid awkward operations and hand positions. A sudden slip could cause the hand to move into the cutting tool or blade.
- ✓ Return all portable tooling to their proper storage place after use.
- ✓ Clean all tools after use.
- ✓ Keep work area clean. Floors should be level and have a non-slip surface.
- ✓ Use good lighting so that the work piece, cutting blades, and machine controls can be seen clearly. Position any shade lighting sources so that they do not cause any glare or reflections.
- ✓ Ensure there is enough room around the machine to do the job safely.
- ✓ Obtain first aid immediately for all injuries.
- ✓ Understand that the health and fire hazards can vary from material to material. Make sure all appropriate precautions are taken.
- ✓ Clean machines and the surrounding area when the operation is finished.
- ✓ Use proper lock out procedures when servicing or cleaning the machines or power tools.

DO NOT

- × Do not distract an operator. Horseplay can lead to injuries and should be strictly prohibited.
- × Do not wear loose clothing, gloves, necktie's, rings, bracelets or other jewellery that can be come entangled in moving parts. Confine long hair.
- × Do not handle cuttings by hand because they are very sharp. Do not free a stalled cutter without turning the power off first. Do not clean hands with cutting fluids.
- × Do not use rags or wear gloves near moving parts of machines.
- × Do not use compressed air to blow debris from machines or to clean dirt from clothes.
- × Do not force the machine. It will do the job safer and better at the rate for which it was designed.



BEFORE OPERATING ANY MACHINE, TAKE TIME TO READ AND UNDERSTAND ALL SAFETY SIGNS AND SYMBOLS. IF NOT UNDERSTOOD SEEK EXPLANATION FROM YOUR SUPERVISOR OR DISTRIBUTOR

2.1 GENERAL METALWORKING MACHINE SAFETY Cont.

HAZARDS ASSOCIATED WITH MACHINES include, but are not limited to:

- Being struck by ejected parts of the machinery
- Being struck by material ejected from the machinery
- Contact or entanglement with the machinery
- Contact or entanglement with any material in motion

Health Hazards (other than physical injury caused by moving parts)

- Chemicals hazards that can irritate, burn, or pass through the skin
- Airborne items that can be inhaled, such as oil mist, metal fumes, solvents, and dust
- Heat, noise, and vibration
- Ionizing or non-ionizing radiation (X-ray, lasers, etc.)
- Biological contamination and waste
- Soft tissue injuries (for example, to the hands, arms, shoulders, back, or neck) resulting from repetitive motion, awkward posture, extended lifting, and pressure grip)

Other Hazards

- Slips and falls from and around machinery during maintenance
- Unstable equipment that is not secured against falling over
- Safe access to/from machines (access, egress)
- Fire or explosion
- Pressure injection injuries from the release of fluids and gases under high pressure
- Electrical Hazards, such as electrocution from faulty or ungrounded electrical components
- Environment in which the machine is used (in a machine shop, or in a work site)

WARNING

MACHINES ARE SAFEGUARDED TO PROTECT THE OPERATOR FROM INJURY OR DEATH WITH THE PLACEMENT OF GUARDS. MACHINES MUST NOT BE OPERATED WITH THE GUARDS REMOVED OR DAMAGED.

2.2 SAFETY PROCEDURES FOR GUILLOTINES

DO NOT use this machine unless you have been instructed in its safe use and operation and have read and understood this manual



Safety glasses must be worn at all times in work areas.



Long and loose hair must be contained.



Rings and jewelry must not be worn.



Sturdy footwear must be worn at all times in work areas.



Close fitting/protective clothing must be worn.



Gloves must not be worn when using this machine.

SAFETY CHECKS BEFORE OPERATING

- Ensure fixed guards are in place to prevent hands or other parts of the body from entering area's of high risk.
- Guards or safety devices must never be removed or adjusted, except by an authorized person for maintenance purposes.
- Working parts should be well lubricated and free of rust and dirt.
- The area around the machine must be adequately lit and kept free of materials, which might cause slips or trips.
- Be aware of other personnel in the immediate vicinity and ensure the area is clear before using equipment.
- Familiarize yourself with and check all machine operations and controls.
- Ensure cutting table is clear of scrap and tools.
- Faulty equipment must not be used. Immediately report suspect machinery.

SAFETY CHECKS WHEN OPERATING

- Do not attempt to cut material beyond the capacity of the machine.
- Never attempt to cut rod, strap or wire with this machine.
- Use correct lifting procedures when handling large sheets of material.
- Take extreme care during the initial feeding of the workpiece into the machine.
- The workpiece should always be held sufficiently far back from the edge being fed into the guillotine.
- Ensure fingers and limbs are clear before operating the guillotine.
- Hold material firmly to prevent inaccurate cutting due to creep.
- When cutting ensure feet are positioned to avoid contact with the foot operated lever.

SAFETY CHECKS AFTER OPERATION

- Remove all off cuts and place them in either the storage rack or waste bin.
- Leave the work area in a safe, clean and tidy state.

POTENTIAL HAZARDS

- Cuts from the sharp edges and burrs on the sheets before and after cutting.
- Parts of the body being caught in crush and pinch points.
- Injuries caused when handling metal sheets.

2.3 LIFTING INSTRUCTIONS

On the day that the machine arrives, make sure that a crane with sufficient capacity is available to unload the machine from the vehicle. Make sure access to the chosen site is clear and that doors and ceilings are sufficiently high and wide enough to receive the machine.

To handle the Guillotine, use only the two sling lifting points located on the top of the end plates. (Fig. 2.3) The slings should be positioned so the machine is level when lifted.

When using slings please take note of the sling angle and the loads that apply

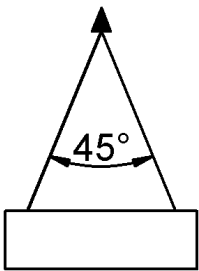

FIG 2.1.

When the slings are at a 45° angle then each sling will carry the equivalent of 50% of load weight. (Fig.2.1).

When the slings are at a 90° angle then each sling will carry the equivalent of 75% of the load weight on each sling. (Fig 2.2)

NOTE! METALMASTER RECOMMEND NOT TO EXCEED 90° ANGLE

FIG 2.2

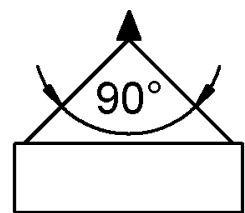

LIFTING POINTS

When lifting the machine only use the lifting points on the machine. (Fig. 2.3) and sling as per diagram below. (Fig. 2.4) Ensure that when lifting, the machine does not tip over.

Check that the lifting slings do not interfere with the hydraulic pipes or electrical conduits. Certified lifting slings only should be used.

Failure to follow these instructions could cause damage to the machine

LIFTING POINT

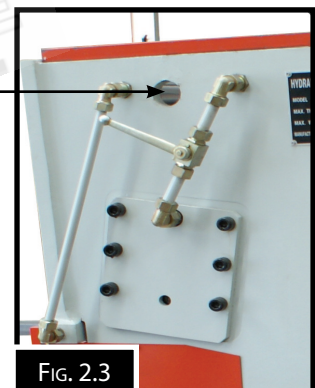

FIG. 2.3

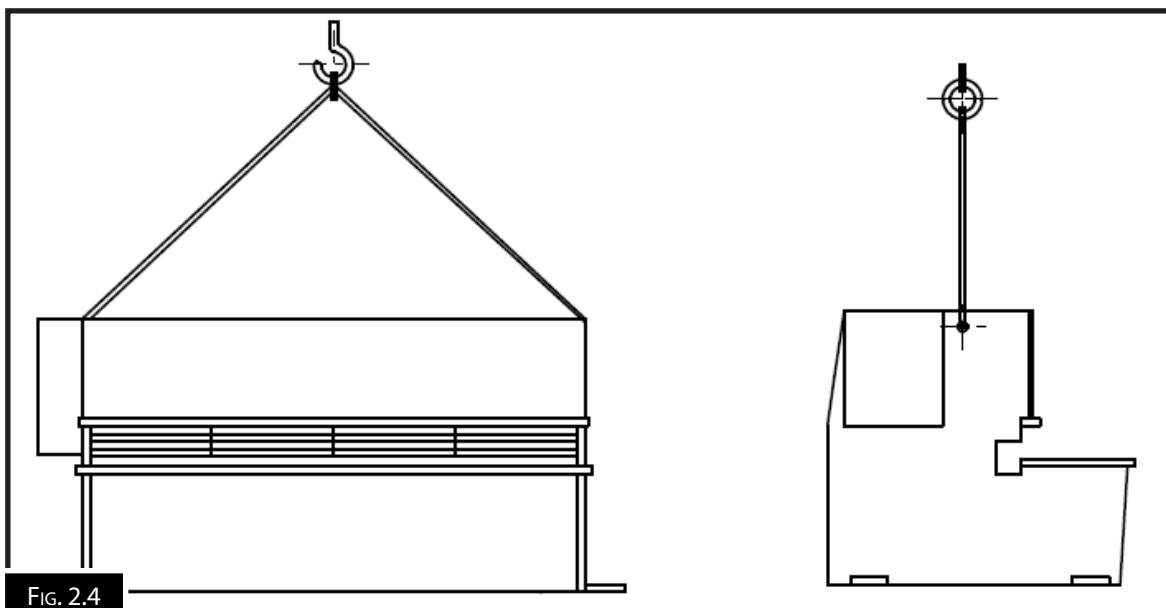

FIG. 2.4

3. SETUP

3.1 CLEAN - UP

The unpainted surfaces of the machine have been coated with a waxy oil to protect them from corrosion during shipment. Remove the protective coating with a solvent cleaner or a citrus based degreaser.

Optimum performance from your machine will be achieved when you clean all moving parts or sliding contact surfaces that are coated with rust prevented products.

It is advised to avoid chlorine based solvents, such as acetone or brake parts cleaner, as they will damage painted surfaces and strip metal should they come in contact. Always follow the manufacturer's instructions when using any type of cleaning product.

3.2 SITE PREPARATION

When selecting the site for the machine, consider the largest size of workpiece that will be processed through the machine and provide enough space around the machine for operating the machine safely. Consideration should be given to the installation of auxiliary equipment. Leave enough space around the machine to open or remove doors/covers as required for the maintenance and service as described in this manual.

It is recommended that the machine is anchored to the floor to prevent tipping or shifting. It also reduces vibration that may occur during operation.

OPTIONS FOR MOUNTING

The machine is best mounted on a concrete slab.

Masonry anchors with bolts are the best way to anchor machinery, because the anchors sit flush with the floor surface, making it easy to unbolt and move the machine later, if needed. (Fig. 3.1)

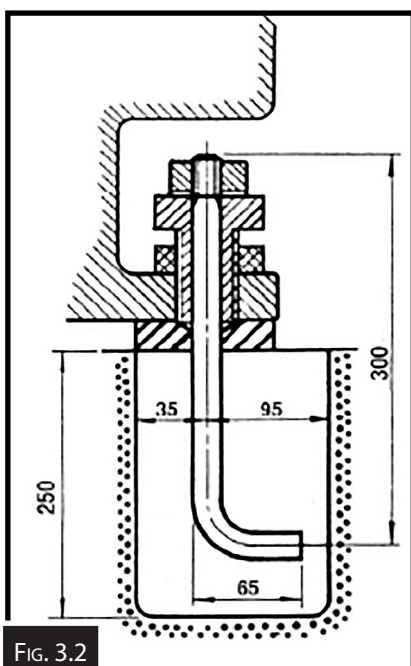

FIG. 3.2

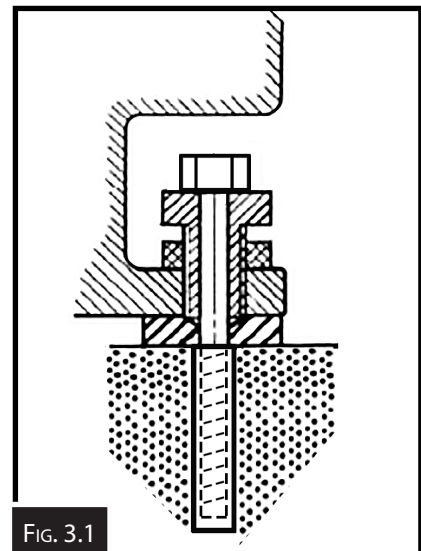

FIG. 3.1

In some case a suitable foundation may not be available and a new one may need to be prepared.

The foundation should be concrete approximately 200mm thick with pockets left clear for the hold down bolts.. The hold down bolts can be "L" shape as per the example in Fig. 3.2

3.3 BASE FOUNDATION AND SECURING POINTS

To optimize the performance of the machine it is important that the foundation for the machine is stable and level. It is best if the machine does not straddle two concrete slabs, but instead is mounted on a single slab. The machine must be leveled and firmly stationed on the floor where it is to be used. The floor load, must be suitable for the weight of the machine. If there is no slab suitable to hold the machine then a solid concrete base must be prepared according to the Foundation Diagram below.

The sizes for the bolt holes position are listed as A-B in the chart below. Check the sizes with the distributor.

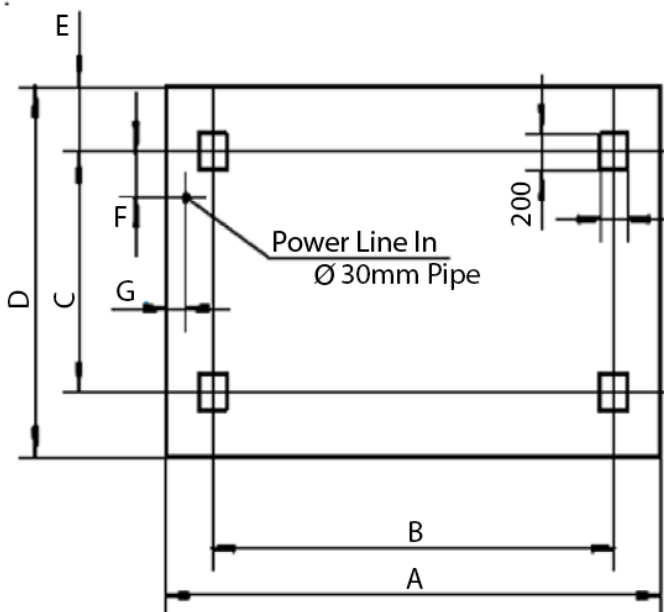
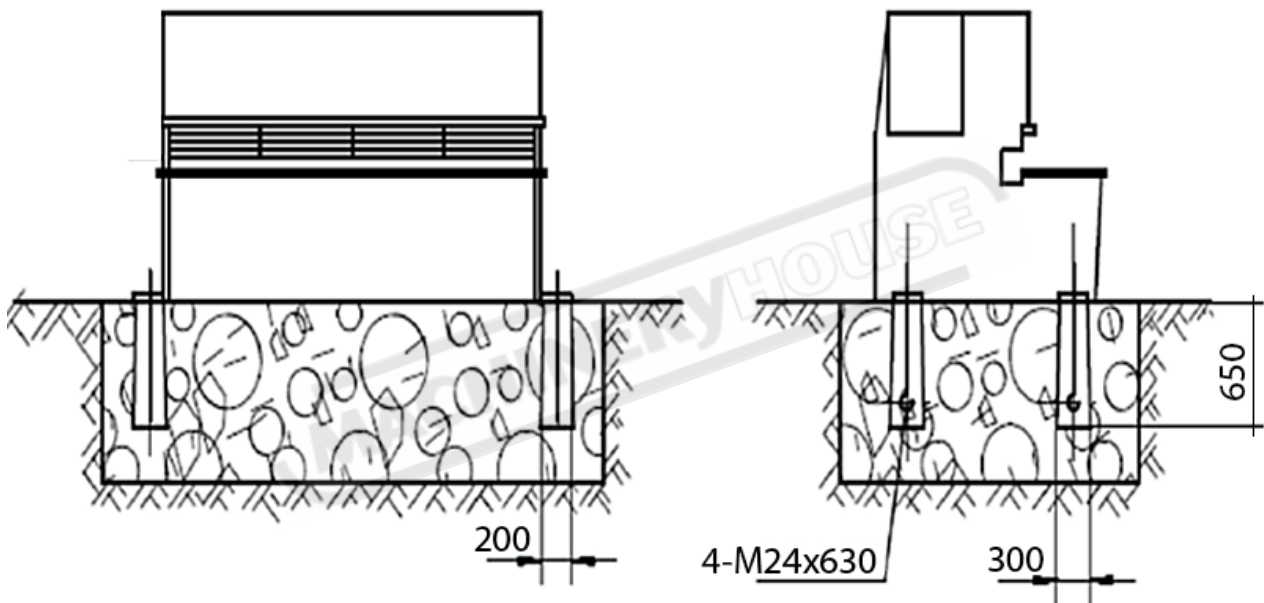

Table of Measurement

Model	A	B	C	D	E	F	G
HG-2504	3500	2840	1000	1750	300	130	100
HG-2506	3500	2880	1150	1900	300	130	100
HG-3206	4200	3583	1350	1900	300	130	100
HG-3212	4700	3655	1450	2350	430	180	350
HG-4006	5000	4382	1500	1900	300	130	100
HG-4012	5500	4445	1550	2550	480	160	350

3.4 ELECTRICAL INSTALLATION

Place the machine near an existing power source. Make sure all power cords are protected from traffic, material handling, moisture, chemicals, or other hazards. Make sure there is access to a means of disconnecting the power source. The electrical circuit must meet the requirements for 415V. To minimize the risk of electrocution, fire, or equipment damage, these machines should be hard wired with installation work and electrical wiring done by a qualified electrician.

NOTE : THE USE OF AN EXTENSION CORD IS NOT RECOMMENDED AS IT MAY DECREASE THE LIFE OF ELECTRICAL COMPONENTS ON YOUR MACHINE.

ELECTRICAL REQUIREMENTS

Nominal Voltage.....415V
Cycle.....50 Hz
Phase.....Three Phase
Power Supply Circuit.....30 Amps

(Full load current rating is available on the specification plate on the motor.)

3.5 FULL-LOAD CURRENT RATING

The full-load current rating is the amperage a machine draws when running at 100% of the output power. Where machines have more than one motor, the full load current is the amperage drawn by the largest motor or a total of all the motors and electrical devices that might operate at one time during normal operations.

Full-Load Current Rating for these machine can be found on the specification plate on the machine.

It should be noted that the full-load current is not the maximum amount of amps that the machine will draw. If the machine is overloaded, it will draw additional amps beyond the full-load rating and if the machine is overloaded for a long period of time, damage, overheating, or fire may be caused to the motor and circuitry.

This is especially true if connected to an undersized circuit or a long extension lead. To reduce the risk of these hazards, avoid overloading the machine during operation and make sure it is connected to a power supply circuit that meets the requirements.



3.6 CHECKING THE POWER SUPPLY

METALMASTER machines are supplied wired ready to run. Check the specification plate on the machine to confirm that the voltage is compatible with the local power supply.

The machine must be connected to the power by a qualified and licensed electrician. Warranty may be voided if it is found that the connection was not carried out by a qualified electrician.

Check the rotation of the motor. If the direction does not match the diagram below, isolate the machine and change the wiring



3.7 MACHINE LEVELING

To set your machine up so that it operates to optimum performance, apply the following procedure. After the guillotine has been anchored to a concrete slab floor, it then needs to be leveled. The leveling is performed using the screws on each pad.(Fig. 3.3). Loosen the hold down bolts and place a level on the surface of the working table. Tolerances: 1000:0.30mm, for both longitudinal and transverse.

Metal plates need to be placed under each jacking screw to distribute the load. Once level then tighten the hold down bolts.

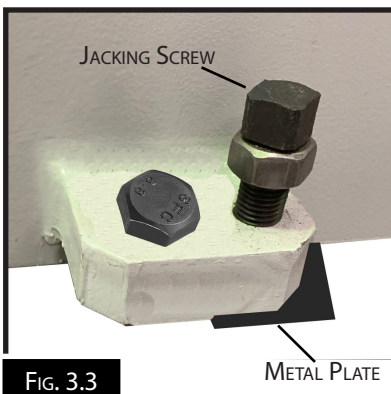

FIG. 3.3



THE MACHINE MUST NOT REST ON SUPPORTS OTHER THAN THOSE DEFINED IN FIG. 3.3

3.8 ATTACHING THE ACCESSORIES.

- Bolt the support arms onto the feed table. Ensure they are level and square to the table. (Fig 3.4)

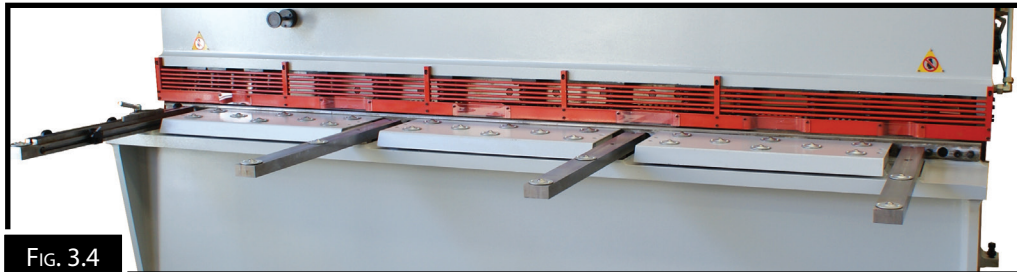
**FIG. 3.4**

- Place the squaring stops Fig 3.5 into position on the table top, securing into place with the bolts supplied. Check that the square stops are square to the blade. Adjust by loosening the bolts and moving by the amount allowed by the clearance of the holes.

**FIG. 3.5**

- Re tighten the screws.

- Unpack and attach the rear fence to the back of the machine. Ensure that the sensors have been connected and set up. (Fig.3.6)

- Unpack the mobile foot control and plug the into the socket provided on the machine. (Fig.3.7)

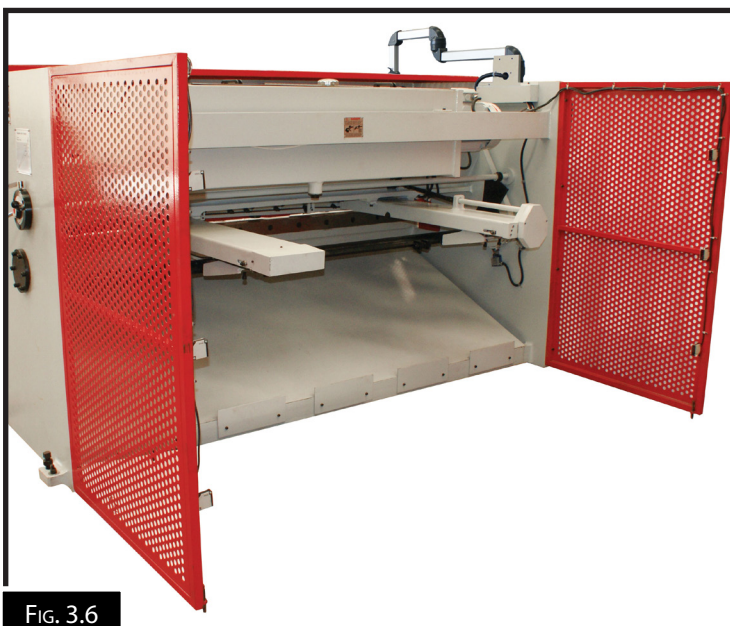
**FIG. 3.6****FIG. 3.7**

3.9 FILL THE HYDRAULIC OIL TANK.

The hydraulic unit is located at the rear of the machine. Take care when accessing the hydraulic oil tank.

When filling the tank with oil, make sure that the top of the tank is clean and free from dust and dirt.

To fill the oil tank:

- Remove the top cover or covers of the hydraulic oil tank, or if a oil pump is available then remove the filler cap.
- Using a pump add the oil into the tank. Metalmaster recommend Shell Tellus Oil 46 or an equivalent.
- Pour or pump the recommended hydraulic oil into the hydraulic oil tank to the specified level of the oil gauge. The specified level is near the middle mark of the oil gauge when the ram is at the maximum opening limit.
- Always maintain this oil level to ensure that the machine operates to its optimum performance.



4. COMMISSIONING

4.1. PREPARATION OF THE MACHINE.

- Remove all wrapping and packing grease from the machine.
- Check the machine for loose bolts. Tighten as required.
- Inspect for oil leakage or loose fittings. Similarly check the main rams between the frames.
- Clean the blades and tighten the securing bolts as required. Examine the cutting edges of both blades for damage.
- Inform your service provider of any damage or faults with the machine.

4.2 CONTROLS

The purpose of this control overview is to provide the novice machine operator with a basic understanding of how the machine is used during operation, and the machine controls and what they do. It also helps the operator to understand if they are discussed later in this manual.

MAIN ISOLATING SWITCH

The main isolating switch is found on the side of the electrical box. This switch cuts the power supply from the power source to the machine. (Fig.3.10)

⚠ WARNING IF ELECTRICAL MAINTENANCE IS CARRIED OUT THEN THE POWER MUST BE DISCONNECTED FROM THE SOURCE BY REMOVING THE FUSES AT THE POWER SUPPLY BOARD.



FIG.3.10

EMERGENCY STOP BUTTONS

The electrical and hydraulic circuits of your machine are designed to allow operation with maximum safety. The following precautions are available on the machine for enhanced safety.

There are five Emergency stop buttons (engaging type) on the machine. Two are found on the front of the machine, one on the foot switch control unit, one on the main control pendant, and one on the back of the electrical cabinet. Once the button has been pressed to reset the emergency stop, the red button must be rotated to reset the stop. (Fig.3.11)

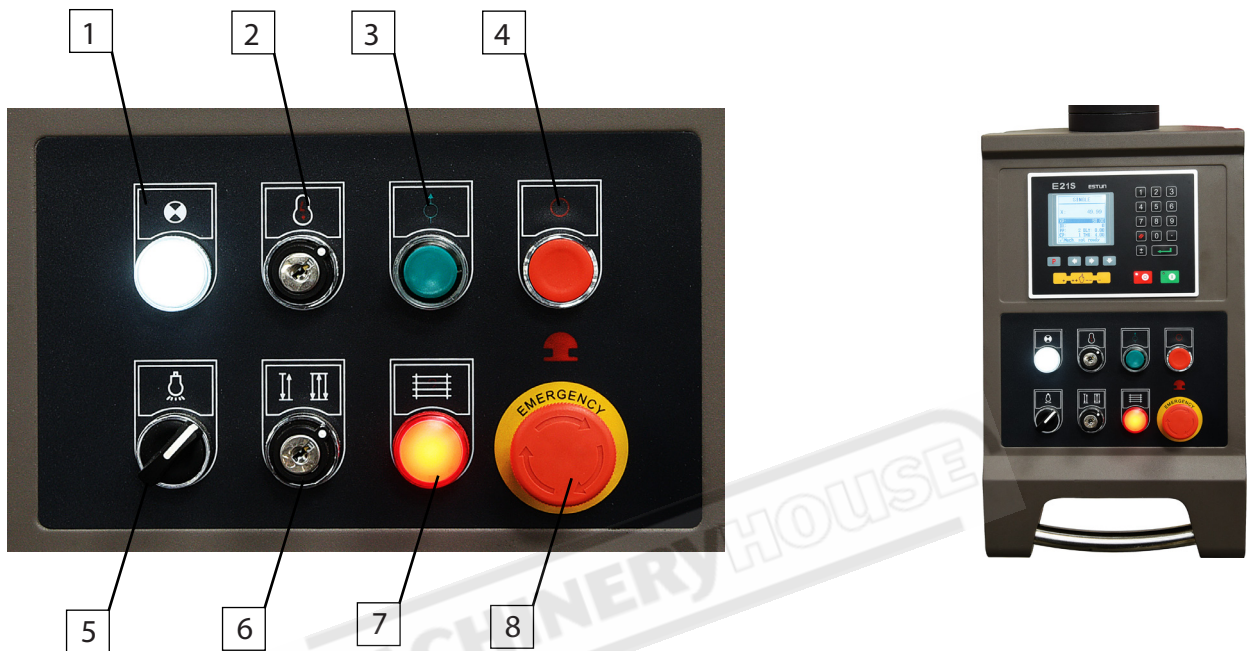

FIG.3.11

4.2 CONTROLS Cont.

Main Controls

The main machine operating controls are located on the pendant.



1	Power On Indicator Light	5	Shadow Line Light ON/OFF
2	Lockout Key Lock to the pump	6	Continuous or Single Cut
3	Illuminated Pump Start Button	7	Rear Guard Sensor Light
4	Hydraulic Pump Stop	8	Emergency Stop

Foot pedal control

Emergency stop button (engaging type) is available on the foot switch control unit.

The foot pedal when pressed activates the shearing beam and must be held in the depressed position until the machine has completed its cut. Releasing the foot pedal during the shearing operation will return the machine to the top of its stroke when controller is set to single cut.

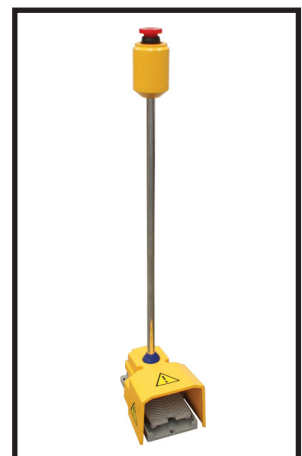

4.3 OMRON E3Z - SAFETY SENSORS OPERATION & ALIGNMENT

The safety circuit consists of a reset switch and two rear side fences, each having 3 sensors. Your machine has a RED warning light on the pendant and a message "Machine Not Ready on the E21S controller. When the main power is switched on the safety circuit must be reset before the hydraulic pump can be started.

A: Basic Control - Light on



B: E21S Control Display



A: Basic Control - Light on : indicates the safety circuit has not been reset.

B: E21S Control Display: "Mach not Ready" indicates the hydraulic pump has not been started.

RESET BUTTON

The green reset button is found on the rear of electrical box

The rear sensors must be aligned before this reset switch can be pressed.



REAR FENCES WITH SENSORS MOUNTED

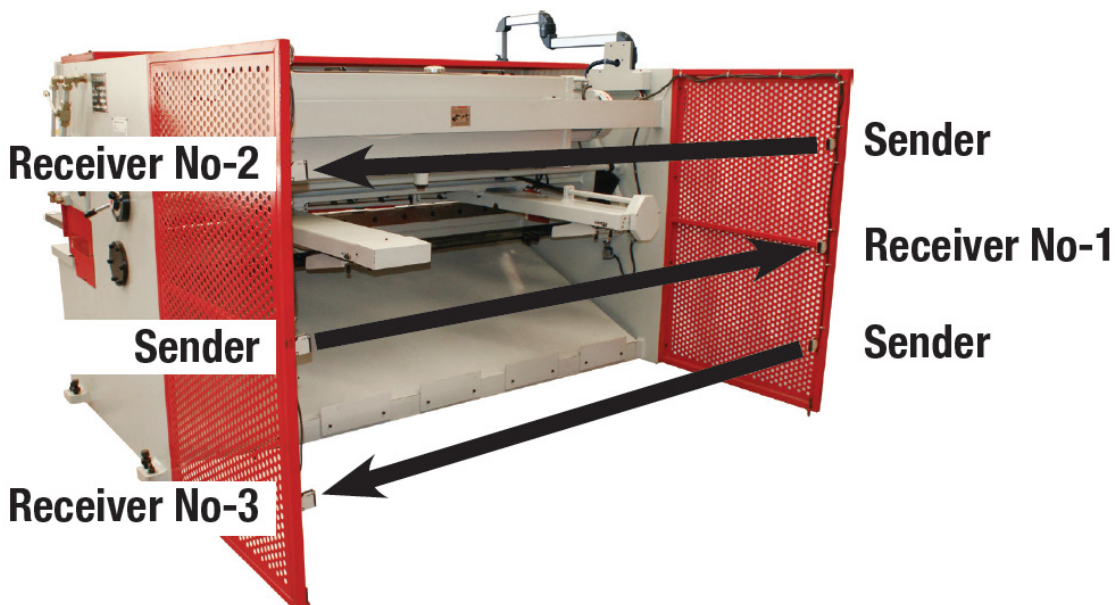

MACHINE SETUP

First ensure that the machine is level and all four leveling jacking bolts are correctly adjusted. Ensure the rear fences are tight and the stabilizing bolt is on the ground to stop the fence moving around.

ALIGNMENT

The sensors are sensitive to alignment so try to align as accurately as possible. If the sender is only slightly aligned with the receiver, any vibration when cutting will stop the pump and the safety circuit will have to be reset again. Alignment could involve loosening the sensor mounting screws or bending the mounting brackets to get the best alignment.

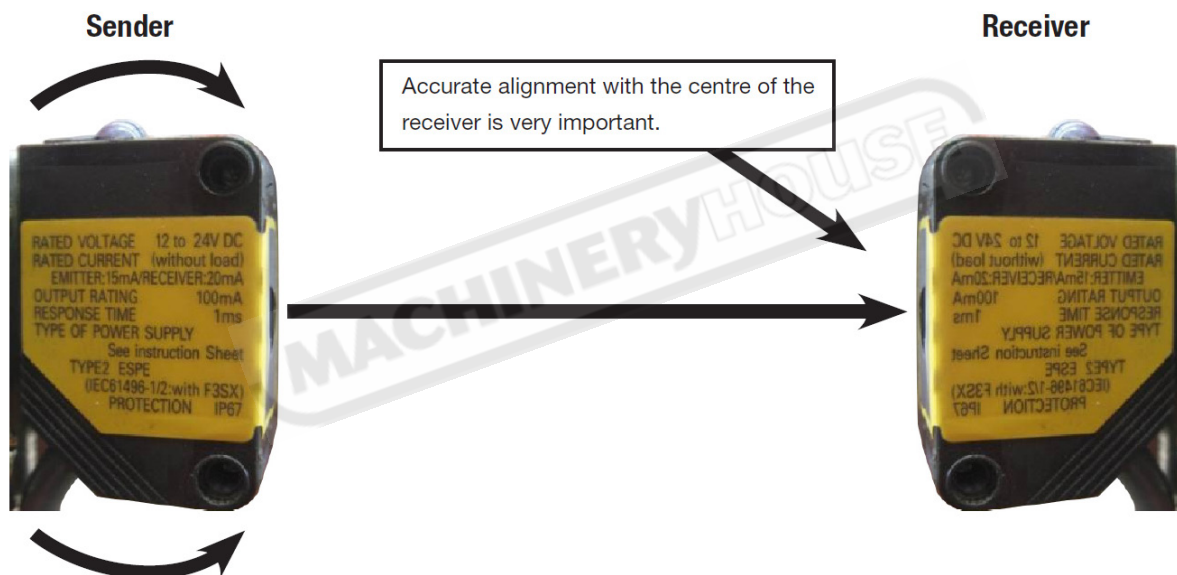

IDENTIFYING SENSORS

SENDERS

Each sender has a red light on top of the unit and a red light on the front. These two lights will be on all the time while the machine has power.



RECEIVER

Each receiver has two lights on top of the unit. These lights indicate if the receiver has power and if it has been aligned correctly with the sender.

No lights on



No Power

Green light on



Power on & not aligned

Green & Orange lights on



Power on & aligned

ALIGNMENT ORDER

The receivers are wired in series and must be aligned in the correct order. As each receiver is aligned correctly it will send power to the next receiver.

No-1 receiver (middle) A green light on indicates it has power. When it is correctly aligned with the sender a orange & green light will be on and it will send power to No-2 receiver.

No-2 receiver (top) A green light on indicates it has power. When correctly aligned with the sender a orange & green light will be on and it will send power to the No-3 receiver.

No-3 receiver (bottom) will have a green light on and when it is correctly aligned with the sender the orange & green light will be on and it will send power to the reset button.

Successful alignment When all 3 receivers are aligned correctly with their corresponding senders, they should all have orange and green lights on top.

5. OPERATION

The Metalmaster Guillotine is designed to perform specific operations that are described in this manual. Many of these operations can be dangerous or deadly if performed incorrectly. The instructions in this section are written with the understanding that the operator has the necessary knowledge and skills to operate this machine. If you are experiencing difficulties performing any operation, stop using the machine! If you are an inexperienced operator, we strongly recommend that you read books, trade articles, or seek training from an experienced operator. **Above all, your safety should come first!**

5.1 STARTING THE MACHINE FOR THE FIRST TIME.

1. Turn the main isolation switch ON and wait for the controller unit to load up.(Fig.5.1)
2. Press the RESET button on the Electrical cabinet. (Fig.5.2)
3. Turn the pump lockout key lock "ON"
4. Press the pump start button. (Fig.5.3)
5. Press the green program start button on the controller (Fig.5.3)



FIG. 5.1



FIG. 5.3

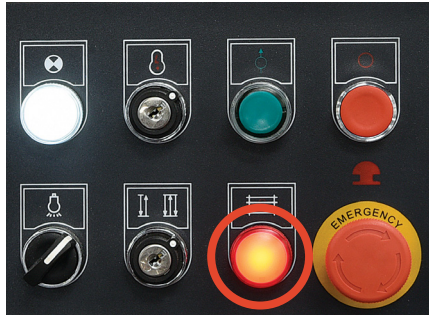

FIG. 5.2

5.2 PERFORM PRE-OPERATIONAL SAFETY CHECK PRIOR TO OPERATING

When the main power is switched on the safety circuit must be reset before the hydraulic pump can be started. This will be displayed only by a RED warning light (A), on the pendant control. The E21S Controller will not display any notification

A: Basic Control - Light on



E21S Control Display



1. REAR SAFETY GUARD CHECK, PLEASE FOLLOW THESE STEPS

1. Start machine as per instruction procedures in "5.1 Starting the Machine For The First Time"
2. Go to the back of the machine, stand outside the rear safety gate & obstruct sensor (1)
3. Ensure the machine has stopped and is disabled
4. Check on the control pendant that the Warning light (A) is illuminated
5. Press the green reset button rear of electrical box refer image (D)
6. Repeat steps 1 to 5 for each of the other sensors (2) & (3)

C: Rear Guarding Sensors

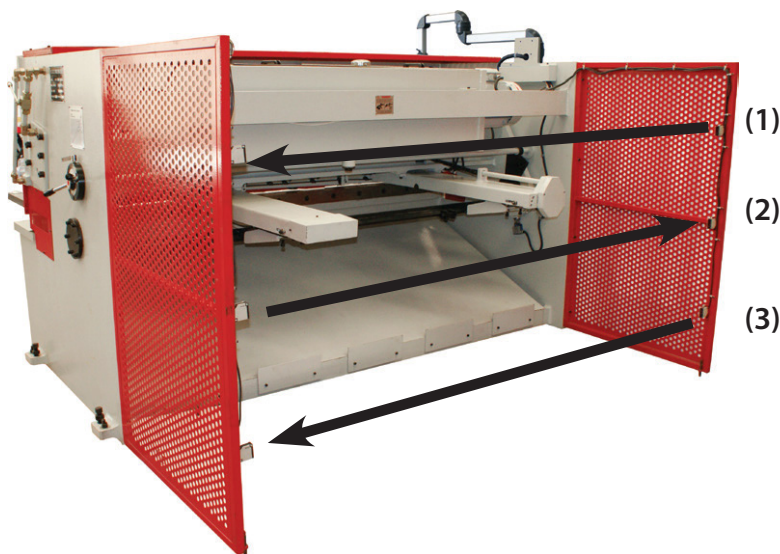

D: Guard Reset Button



5.3 TESTING THE EMERGENCY STOPS.

The Metalmaster Guillotines are fitted with four emergency stop buttons. One is on the mobile foot pedal and one is on the pendant control panel. The other two emergency stop buttons are on the front of the guillotine. They should be tested one at a time to ensure they are all working correctly.

To test the emergency stops:

1. Make sure that all the emergency buttons have been reset
2. Start the machine and then press the emergency stop on the pendant. The machine's hydraulic pump should stop and the power should be cut off. (Fig.5.5)
3. Try to restart the hydraulic pump by pressing the green pump start button. If the pump will not start then the emergency stop is working correctly.
4. Reset the emergency button by twisting the top red section until the red section pops up.
5. Press the green pump start button again. The pump should now start. The emergency stop is working correctly.
6. Repeat steps 1-5 for each of the other emergency stop buttons. (Fig.5.6)

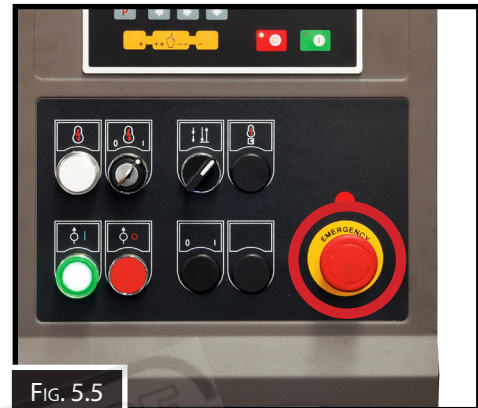

FIG. 5.5



FIG. 5.6



NOTE: BEFORE STARTING THE OPERATION OF THE MACHINE, CHECK THAT THERE ARE NO PERSONS AND OBSTACLES AROUND THE MACHINE. PAY PARTICULAR ATTENTION TO THE REAR OF THE MACHINE. NEVER PLACE HAND TOOLS AND PARTS BETWEEN THE BLADES

5.4 E21S GUILLOTINE CALIBRATION: X AXIS

The Metalmaster Guillotine is calibrated before the machine leaves the factory and should not need any further adjustments. However should the machine at any time need to be calibrated, the following is the procedure.

NOTE: BEFORE PROCEEDING TO CALIBRATE THE X AXIS, PLEASE ENSURE THE BACK GAUGE IS PARALLEL TO THE CUTTING BLADE. REFER PAGE 36 FOR BACK GAUGE PARALLEL ADJUSTMENT

1. Use a rule and manually move back gauge until it measures 100mm between the back gauge and the edge of the bottom blade.

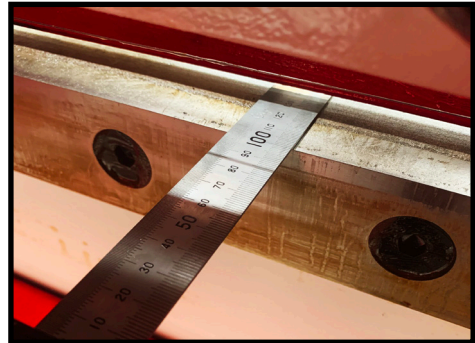

2. Press P until "CONST" page is located.



3. Type password (1212) and press enter to locate Teach screen.

4. In the teach screen, highlight X, and type 100 and then press enter.

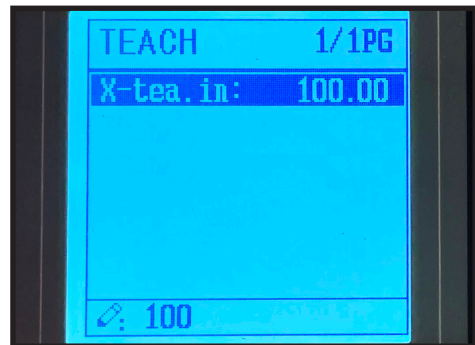

5. Press P twice to exit and return to the "Single" page..

6. Check X = 100mm on the "Single" page.

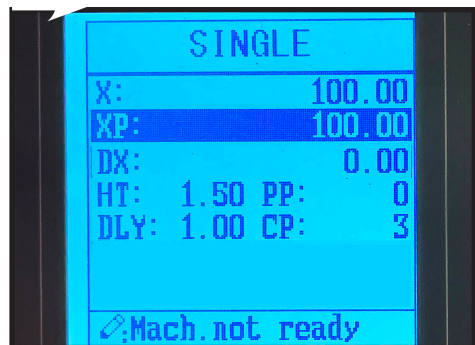

NOTE: THE MANUAL BACK GAUGE ADJUSTER SHOULD NOT BE MOVED WHEN THE POWER TO THE MACHINE HAS BEEN CUT. THIS MOVEMENT WILL CAUSE THE X" AXIS TO BE OUT OF CALIBRATION. IF THIS HAPPENS THEN THE PROCEDURE ABOVE WILL NEED TO BE DONE AGAIN.

5.5 ESTUN E21S GUILLOTINE CONTROLLER OPERATION

SINGLE: Common page that is used by anyone who wants to re-write a job.



X - (X Back gauge actual position)

XP - (X Program Position) - Back gauge distance from the blade

DX - (Distance of Back Gauge Retraction) - Amount the back gauge will retract when cutting

PP - (Program Pieces) - Number of pieces to be cut

DLY - (Delay Retraction) - Time delay in seconds for the back gauge to retract when cutting

CP - (Completed Pieces) - Amount of pieces that have been completed

TMR - (Timer) - Set timer to ensure material cuts all the way through - Approx. 1 sec = 600mm

Operation: With XP highlighted, type 100 and press the enter button. Continue the same process until all parameters have been entered and then press green program start button. The controller will now find X position. Once it has found position you can start cutting material.

Example: This job will cut 100mm. There is no retraction and no delay. There are 4 pieces to cut and 0 pieces have been completed so far. The blade will travel approximately 1200mm

PROG: Program management page



This page gives access to all the saved programs, there are 40 programs and ability to save 25 steps for each program.

Operation: Press the **P** (program button) until Program management page has been located. Enter **1** and press enter, this will take you straight to the Product Information Page for program **No-1**.

PROG: Product Information Page

This page lets you enter parameters for the pieces to be cut.

ST - (Steps) - How many different length pieces to be cut in 1 program

PP - (Programmed Pieces) - Number of pieces to be cut

CP - (Completed Pieces) - Amount of pieces that have been completed

DLY - (Delay Retraction) - Time delay in seconds for the back gauge to retract when cutting

TMR - (Timer) - Set timer to ensure material cuts all the way through - Approx. 1 sec = 600mm

PROGRAM1	
ST:	2
PP:	5
CP:	4
DLY:	1.00
TMR:	3.00
Range: 0~25	

Operation: With ST highlighted type 2 and press the enter key, this will save parameter and PP will then be highlighted. Continue until all desired parameters have been entered.

Example: This program has 2 different length pieces to be cut and is repeated 5 times. 4 pieces have been cut, the back gauge has a 1 second delay and the blade has a cut width of three seconds.

PROG: Individual Cut Information Page

This page lets you enter information for each individual cut.

X - (X Back Gauge - actual position)

XP - (X Program Position) - 100mm back gauge distance from the blade

DX - (Distance of Back Gauge Retraction) - 5mm back gauge retraction

RP - (Repeat) - This cut will be repeated 2 times

PROGRAM1 1/2	
X:	100.00
XP:	100.00
DX:	5
RP:	2
Range: 0~9999.999mm	

Operation: With X highlighted, type 100 and press the enter button. Continue the same process until all desired parameters have been entered. Once all cuts have been completed press **arrow across and enter parameters for step 2.**

Example: Program 1 has 2 steps and step 1 will be repeated before program moves to step 2.

5.6 SETTING THE BLADE GAP

Setting the blade gap correctly will prolong the life of the blades and most likely, the guillotine itself. Too tight and excessive forces will be needed to shear the metal, and not tight enough the metal may jam in the gap. To adjust the blade gap for the material thickness and type, first check the chart on the side of the machine (Fig 5.7) for the recommended settings.

GAP ADJUSTMENT TABLE

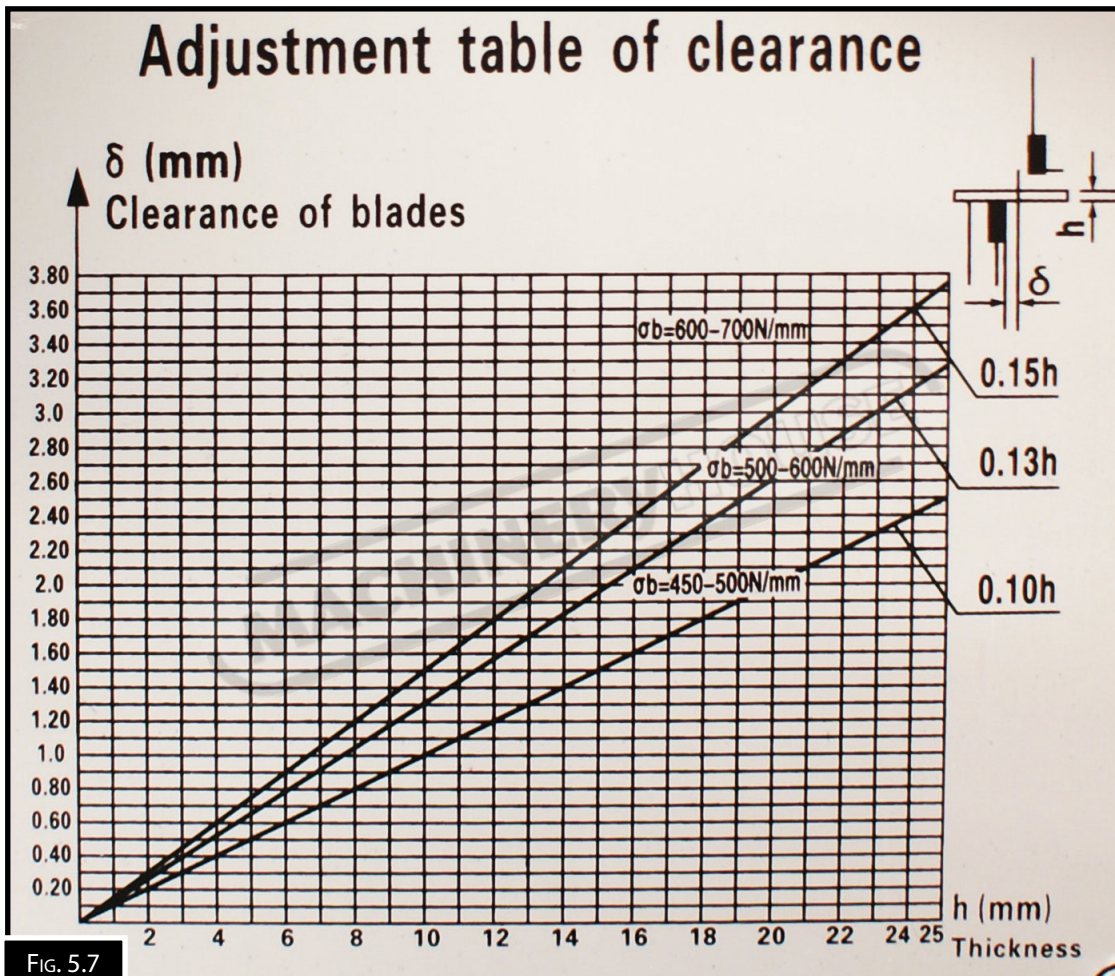

FIG. 5.7

Once the chart has been checked then adjust the blade clearance.

To Adjust The Gap:

1. Loosen the clamp at the top of the hand-wheel.
2. Turn the hand wheel (Fig 5.8) to the correct graduated setting.
3. Tighten the clamp on top of the hand wheel.

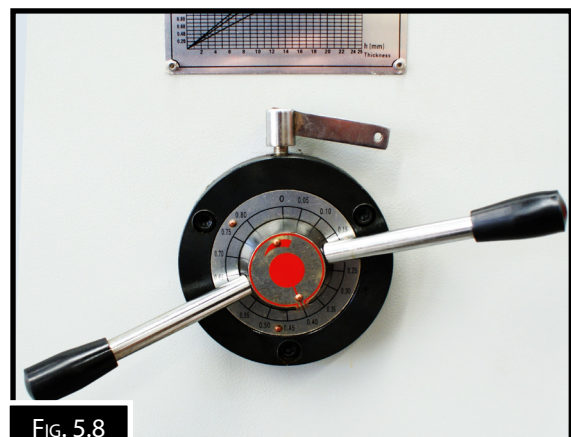
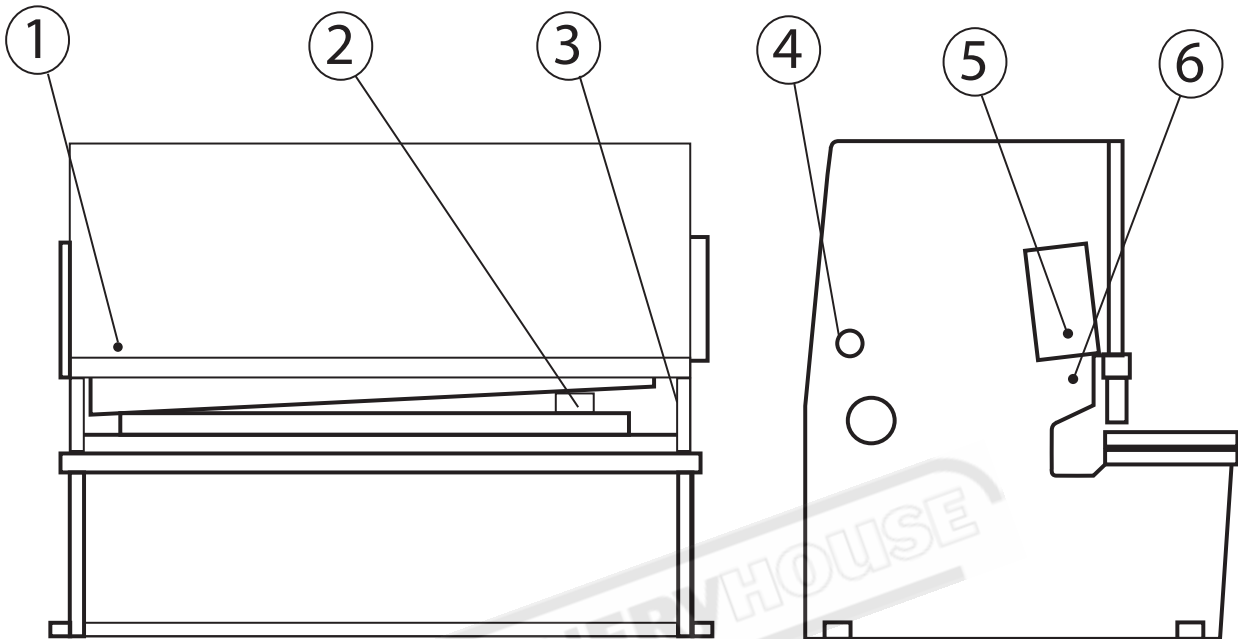

FIG. 5.8

6. MAINTENANCE AND INSPECTION**6.1 TYPE AND FREQUENCY OF INSPECTIONS**

Inspection	Period	Responsibility
Lubrication of all grease points	Daily	Operator
Lubrication of slide-ways	Weekly	Operator
All Guards that protect against physical damage	Daily	Operator
Machine fixing bolts against loosening	Weekly	Operator
Oil leakage in cylinders	Weekly	Operator
Hydraulic Oil Change and filter	1000hrs	Maintenance
Oil leakage in pipes, hoses and hydraulic elements	Weekly	Operator
Hydraulic fluid level	Weekly	Operator
Cylinder connections bolts against loosening	Weekly	Operator
Safety & limit switches against loosening, damage	Weekly	Operator
Terminal connections of the electrical installation	Annually	Electrician
Back Gauge drive Belt Tension	Weekly	Operator

6.2 LUBRICATION POINTS**Lubricants.**

- Cylinder and main pivot points - grease.
- Back-stop: shafts, screws, nuts - grease.
- Shear beam slides - grease.
- Hydraulic oil #46.

6.3 CHANGING THE HYDRAULIC OIL

All precautions must be taken to keep the hydraulic system clean at all times. When changing oil, make sure that the top of the oil tank is clean and free from dust and dirt.

To change the hydraulic oil:

1. DISCONNECT THE MACHINE FROM THE POWER SUPPLY
2. After removing the dust and dirt from the top of the tank, remove the socket head cap screws that secure the tank top cover and remove the cover or covers. (Fig 6.1)
3. Using an appropriate pump, drain out the old oil completely. Be sure nothing is left.
4. Unscrew the filter and replace with a new filter
5. With a clean cloth wipe the bottom of the tank to ensure that all contaminants have been removed.
6. Using a pump, add the new oil into the tank.
7. Oil level must be filled until the oil reaches the centre of the oil sight glass.
8. Always keep the oil at the specified level.

NOTE: OIL MUST BE CHANGED AFTER THE FIRST 200 WORKING HOURS OF USE, AND THEN AFTER EVERY 1000 WORKING HOURS (SEE: LUBRICATION FREQUENCY).

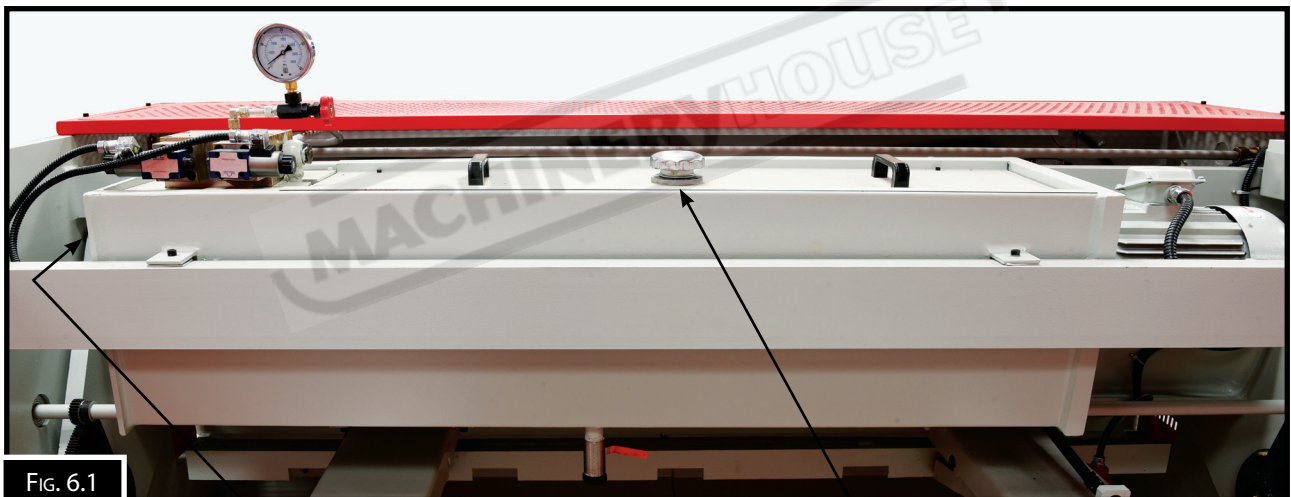

FIG. 6.1

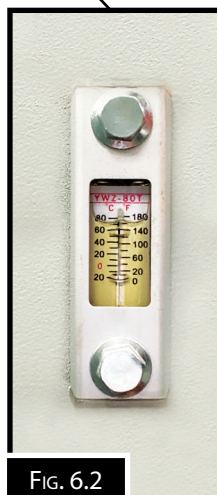

FIG. 6.2

SIGHT GLASS



FIG. 6.3

FILLER CAP

6.4 CHANGING THE FILTER

When dirt, dust, and other foreign matter are deposited in large amounts in the hydraulic circuit, the hydraulic pump may produce abnormal noise and decrease in discharge capacity, causing the cutting speed to slow or the top blade to vibrate. These conditions are attributable to the plugging of the filter in the hydraulic oil tank. When changing the Hydraulic oil always replace the filter.

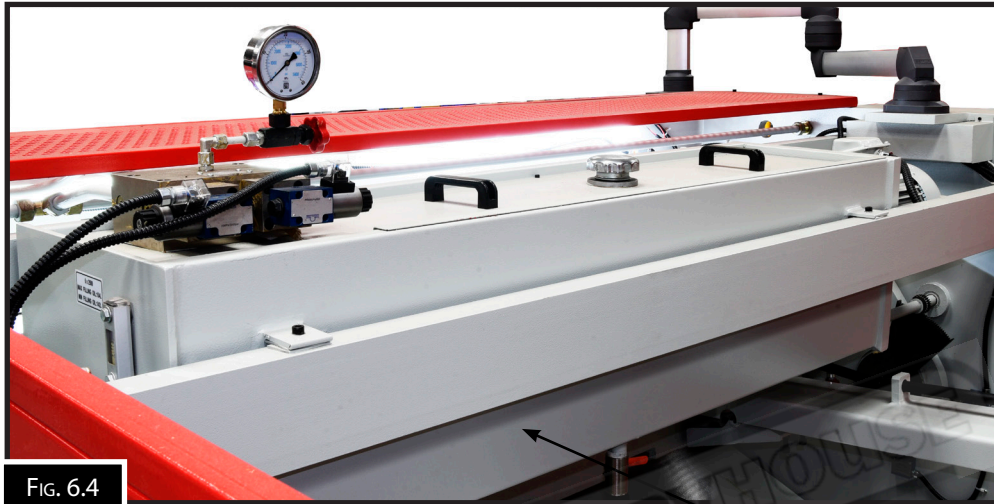

FIG. 6.4



FIG. 6.5

To Change The Filter

1. DISCONNECT THE MACHINE FROM THE POWER SUPPLY.
2. With a clean cloth, remove any dust or debris from the top of the tank to insure that nothing accidentally enters into the tank.
3. Remove the socket head cap screws that hold down the cover and remove the cover from the oil tank. (Fig.6.4)
4. Remove all the oil from the oil tank and wipe the inside of the tank clean with a cloth to remove any contaminants left in the bottom of the tank..
5. Unscrew the old filter from its place inside the oil tank (Fig.6.5)
6. Screw the new filter into its place in the tank and replace the cover and refill the tank with clean new oil.

NOTE: THE SUCTION FILTER ELEMENT MUST BE CLEANED AFTER THE FIRST 200 HOURS OF USE, AND THEN AFTER EVERY 1000 WORKING HOURS. REPLACE IF DAMAGED OR UN-SERVICEABLE.

6.5. BLADE PARALLEL ADJUSTMENT.

The following information applies when fitting new or sharpened blades.

This is a two man job where one will need to check the blade clearance with a feeler gauge (Fig 6.6) from the rear of the machine while the other adjusts the blade holder setting.

- The clearance must be checked across the full length of the blades.
- Use a feeler gauge, to test the clearance.
- According to the test adjust the clearance.

NOTE: BEFORE DEPRESSING THE FOOT PEDAL CHECK THAT THE BLADES WILL PASS AND WILL NOT TOUCH. IF THE BLADES TOUCH, DAMAGE MAY BE CAUSED TO THE CUTTING EDGE.

To Check The Clearance At Set Intervals On The Blade.

1. Set the selector control on the control box to normal operation function.
2. Depress the foot pedal and move the blade to the maximum down stroke position then shut off the ball valve (Fig 6.7) to hold the stroke in the down position.
3. DISCONNECT THE MACHINE FROM THE POWER SUPPLY.
4. Release the ball valve slowly to allow the upward movement of the top blade to check the clearance at set intersection intervals of the blades.
5. Once the clearances are equal and the blades parallel, tighten all fasteners and locknut's and release the ball valve fully.
6. RE-CONNECT THE POWER SUPPLY and cycle the machine a few times.
7. Take a test cut to ensure that the cut is clean and without burrs.
8. This operation may be required to be repeated until the clearance is parallel.

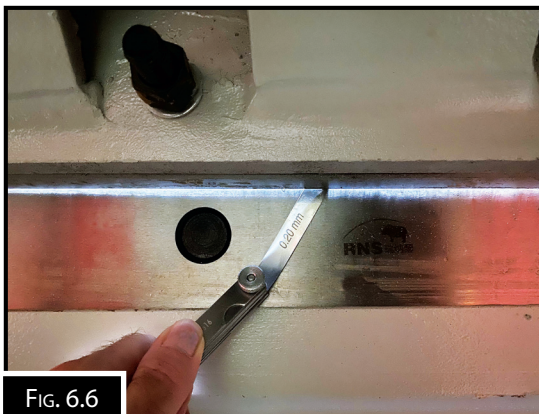

NOTE: THE BLADES ARE VERY SHARP AND CAN CUT VERY EASILY. USE THICK LEATHER GLOVES WHEN HANDLING THE BLADES AND ALWAYS USE A HELPING HAND WHEN INSTALLING NEW OR RESHARPENED BLADES.

6.6 MAINTAINING THE BACK GAUGE

A well maintained machine optimise's the performance and longevity of the machine. This is no more important than with the back gauge drive mechanism. Failures in this area can do a lot of damage. The main area that needs to be checked is the belt drive that ensures the back gauge travels in and out equally on each side. For this reason the belt adjustment must be correctly adjusted and maintained. (Fig 6.8)

To adjust the belt:

1. DISCONNECT THE MACHINE FROM THE POWER SUPPLY



2. Loosen the socket head screw and adjust the belt (Fig.6.9)

NOTE: BEFORE ANY FINAL TENSIONING IS TO BE APPLIED MAKE SURE THAT THE TIMING BELT TEETH ARE FULLY SEATED IN THE TOOTH GROOVES ON BOTH TIMING BELT PULLEYS. CHECK TO MAKE SURE THAT THE TIMING BELT TEETH STAY SEATED IN THE TOOTH GROOVES BY ROTATING THE DRIVE SYSTEM BY HAND.

3. The tension on the belt should be the amount of deflection when the belt is pressed between the pulleys. The deflection should be approximately 1.2mm for every 100mm of span length.

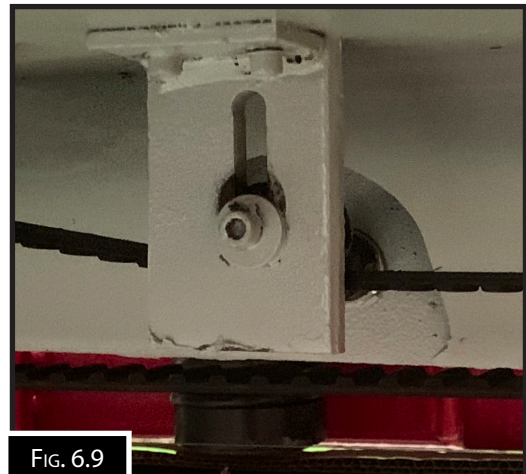

6.7 BACK GAUGE PARALLEL ADJUSTMENT.

From time to time the back gauge may become out of parallel. This can happen when the machine is only used on one side of the machine. For this reason it is best to vary the position along the blades where the material is cut. If the back gauge does become out of parallel, then follow the procedure below. There are five adjusting screws on each arm.

The centre screw is adjusted to set the distance from the blade.(Fig.6.10)

The four adjusting screws are to set the tilt on the back gauge.

NOTE: THE BACK GAUGE SHOULD BE TILTED BACK AT THE TOP TO ENSURE THE MATERIAL IS CLEARED WHEN THE SWING ARM SWINGS DOWN



To adjust the back gauge:

1. Adjust the back gauge to a gap of 20mm
2. With a small strip of steel take a cut at each end of the blade and one in the centre.
3. Measure each piece to determine if the back gauge is parallel. If adjustment is required.
4. DISCONNECT THE MACHINE FROM THE POWER SUPPLY
5. Select the arm that needs to be moved in towards the blade. Loosen the 4 lock nuts on the jacking screws and adjust the 4 set screws so that the back gauge tilts back at the top approximately 1-2 degrees. (Fig.6.11)
6. Loosen the centre lock screw on the arm that needs to be moved in towards the blade and adjust the centre screw as required. (Fig.6.12)
7. When adjusted correctly tighten all the lock screws.
8. Re connect the power and take a test cut. If the back gauge is not parallel then repeat steps 2-7 again.

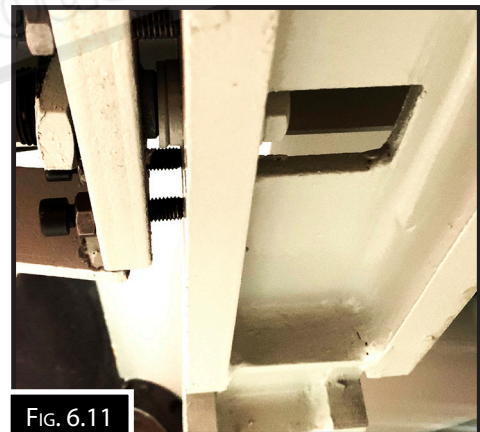

6.8 TROUBLESHOOTING

PROBLEM	POSSIBLE CAUSES	ACTION
Machine shudder on the down stroke.	<ul style="list-style-type: none"> • Incorrect relief valve setting 	<ul style="list-style-type: none"> • Re-adjust relief valve. Adjust the relief valve by unlocking the hexagon head grub screw on the side of the body of the valve. Turn in a clockwise direction closing the valve while cycling the machine.
Machine will not cut.	<ul style="list-style-type: none"> • Low system oil pressure • Check the blades for excessive clearance or damage to the cutting edges 	<ul style="list-style-type: none"> • Check the system pressure. (See page 4) • Check the oil level (See page 17). • Check the blade gap (See page 29). • Reset or regrind the blades as required
Machine will not stop in the neutral position.	<ul style="list-style-type: none"> • Check limit switch /relay • Check directional control valve 	<ul style="list-style-type: none"> • Replace if necessary. • Remove valve, check and replace if necessary
Clamping does not work	<ul style="list-style-type: none"> • No clamping pressure 	<ul style="list-style-type: none"> • Check the system pressure. (See page 4) • Check electrical circuit
Oil leaking from cylinder	<ul style="list-style-type: none"> • Gland seal is damaged 	<ul style="list-style-type: none"> • Change seal
Oil leaking from fittings	<ul style="list-style-type: none"> • Fittings are loose 	<ul style="list-style-type: none"> • Tighten fittings
Back Gauge length does not match Controller	<ul style="list-style-type: none"> • Back Gauge out of calibration • Back Gauge drive belt faulty 	<ul style="list-style-type: none"> • Calibrate back gauge (refer page • Check the tension of the back gauge drive belt (See page 35)
Machine will not start	<ul style="list-style-type: none"> • Rear guarding sensors out of alignment • Emergency stop buttons not released. • Electrical overload protection tripped • Pump lockout key lock switched off 	<ul style="list-style-type: none"> • Align rear sensors (See page 20) • Check emergency stop buttons (See page 25) • Reset overload trip switch • Switch pump key lock "ON"

A. HYDRAULIC CIRCUIT FOR HG-2504, HG-2506, HG-3206, HG-4006

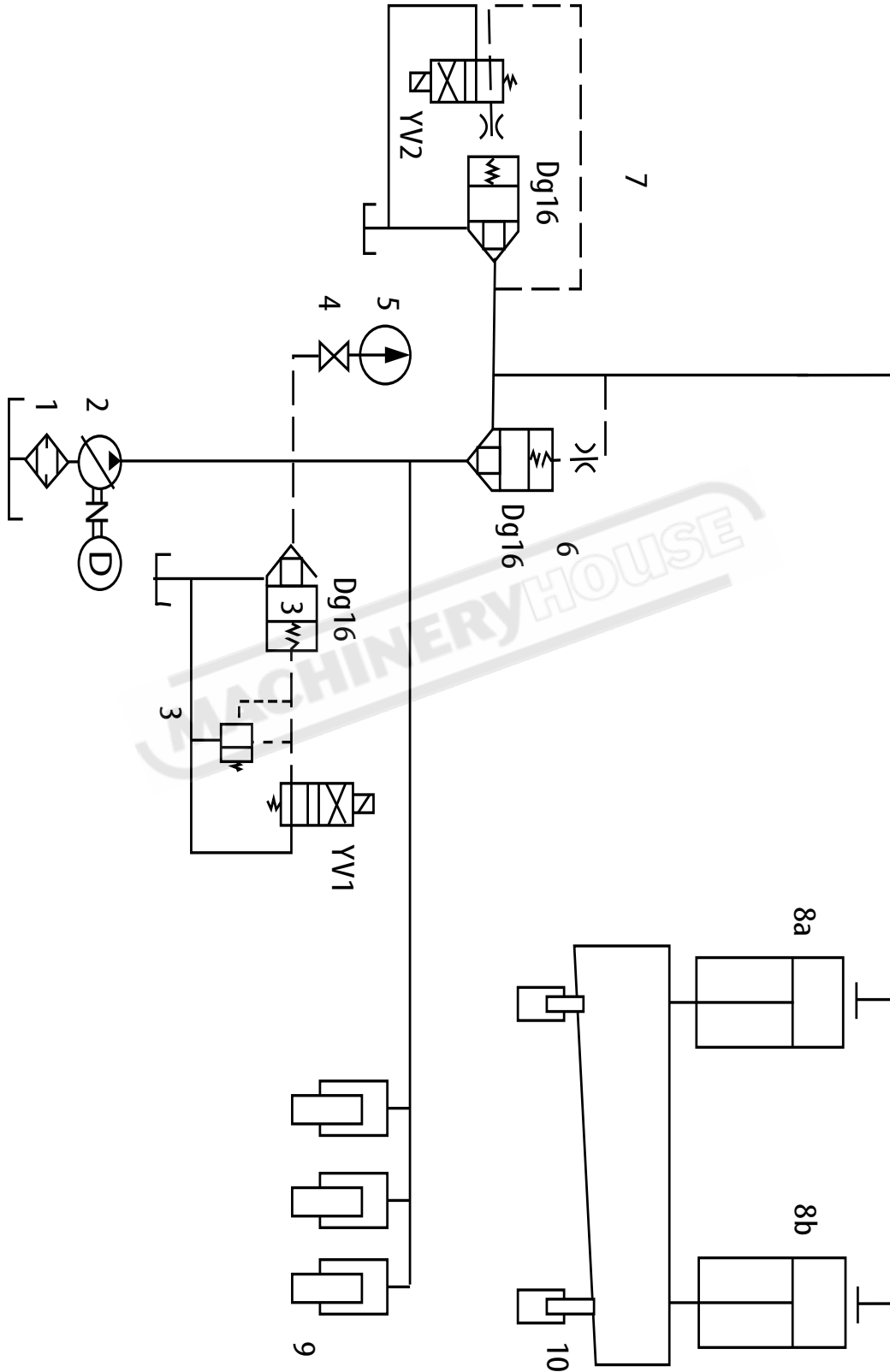

A. HYDRAULIC CIRCUIT FOR HG-3212, HG-4012

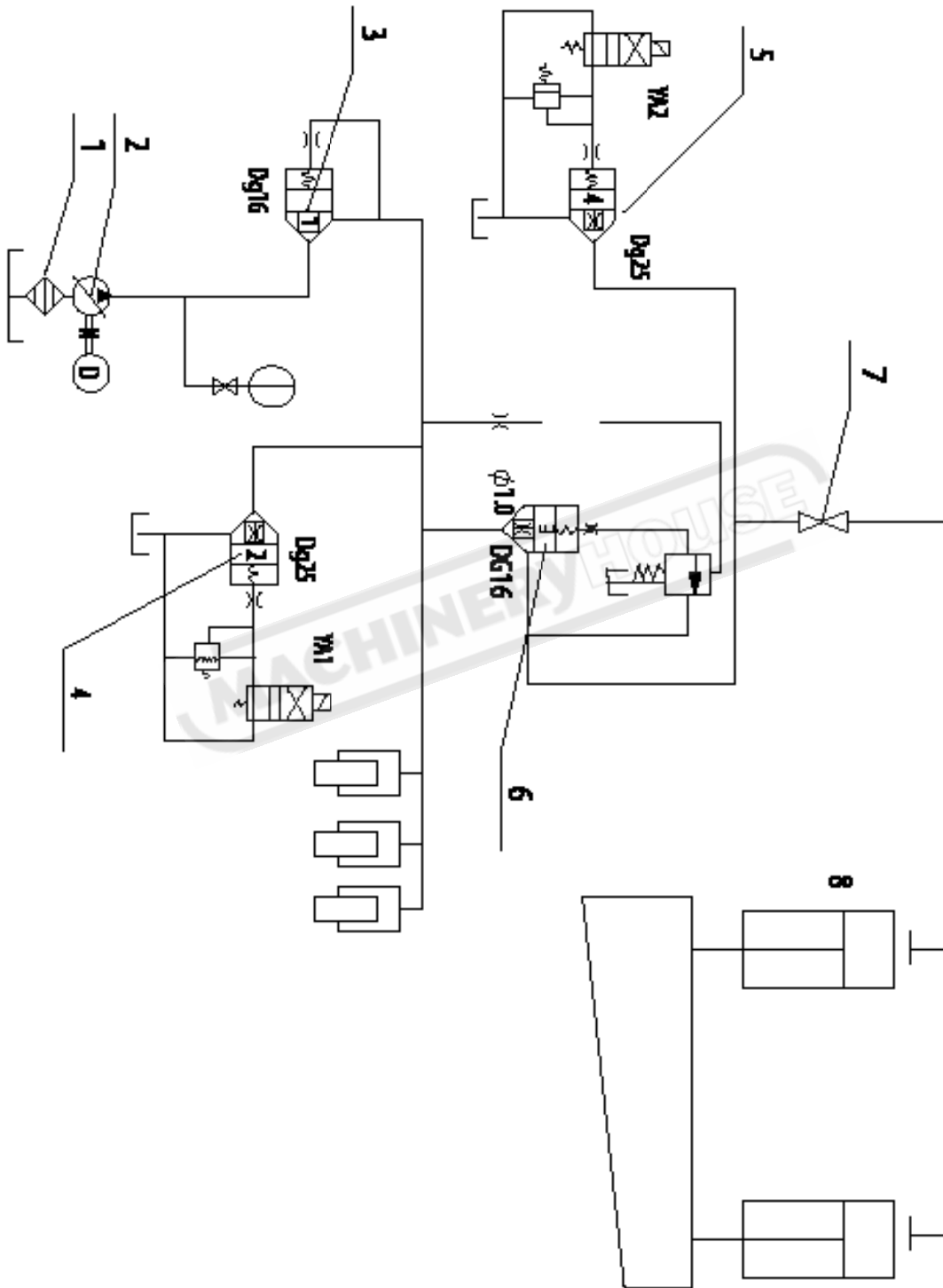

WIRING DIAGRAM FOR HG-2504, HG-2506, HG-3206, HG-4006 (PAGE 1)

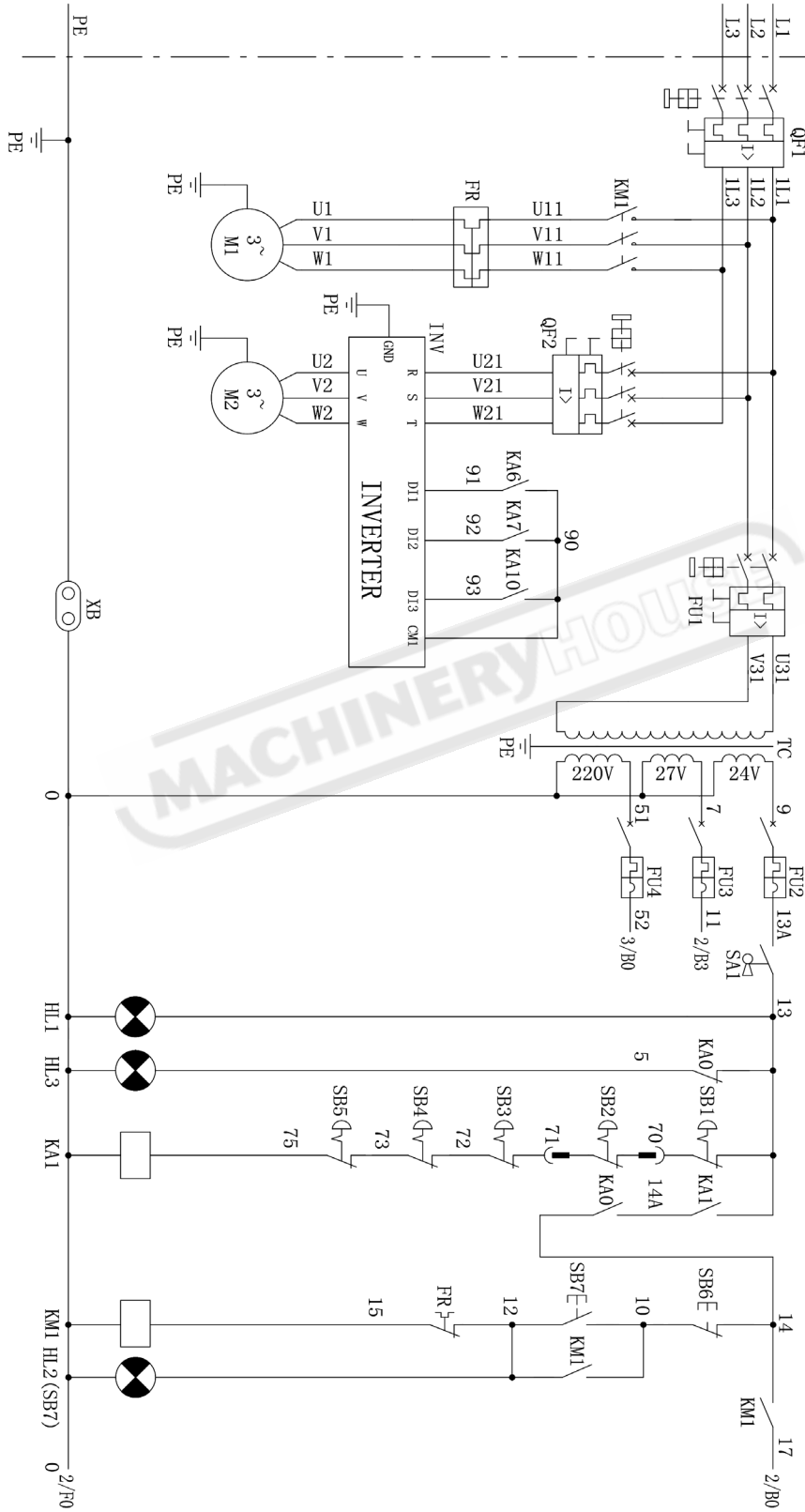

WIRING DIAGRAM FOR HG-2504, HG-2506, HG-3206, HG-4006 (PAGE 2)

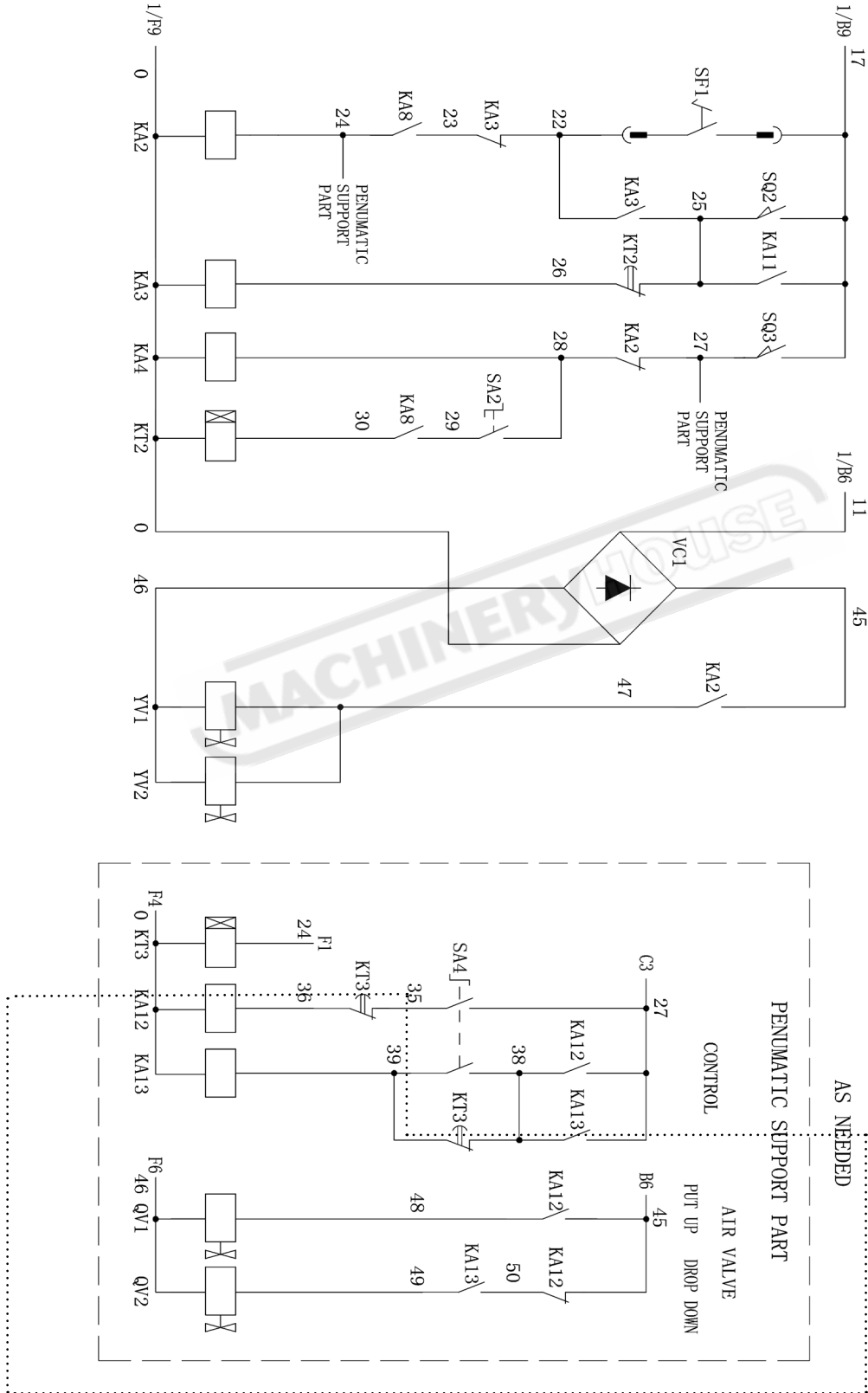

WIRING DIAGRAM FOR HG-2504, HG-2506, HG-3206, HG-4006 (PAGE 3)

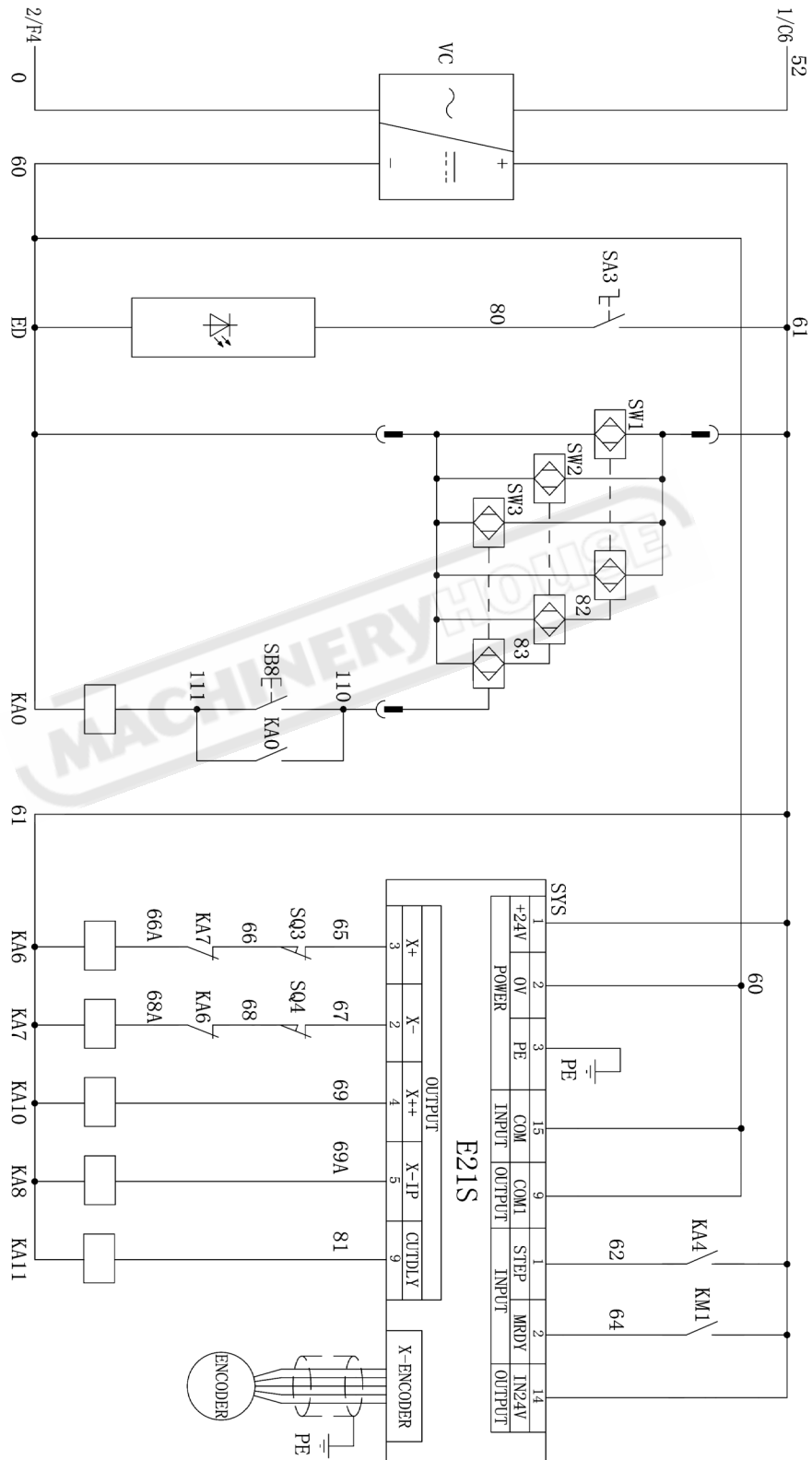

WIRING DIAGRAM FOR HG-3212, HG-4012 (PAGE 1)

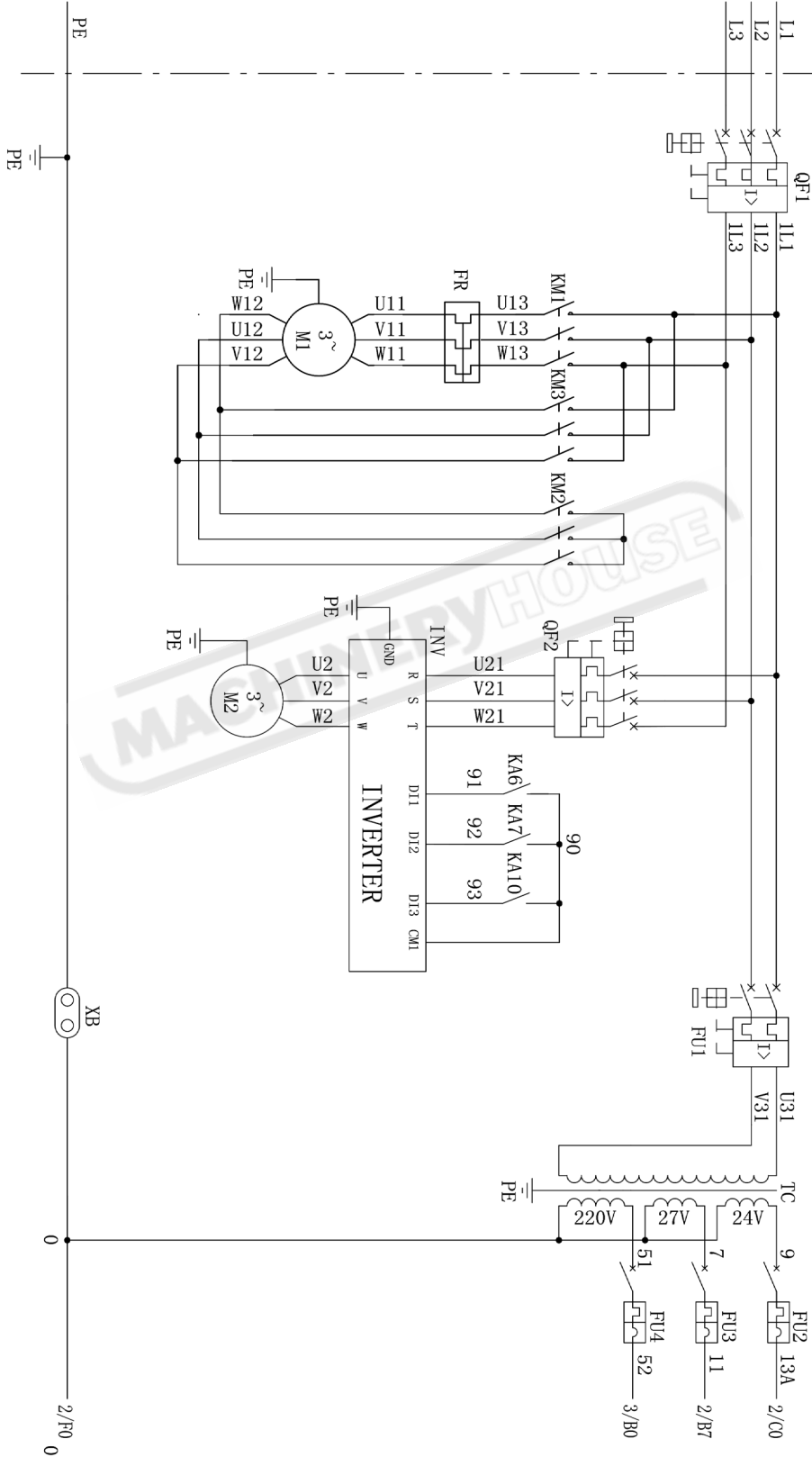

WIRING DIAGRAM FOR HG-3212, HG-4012 (PAGE 2)

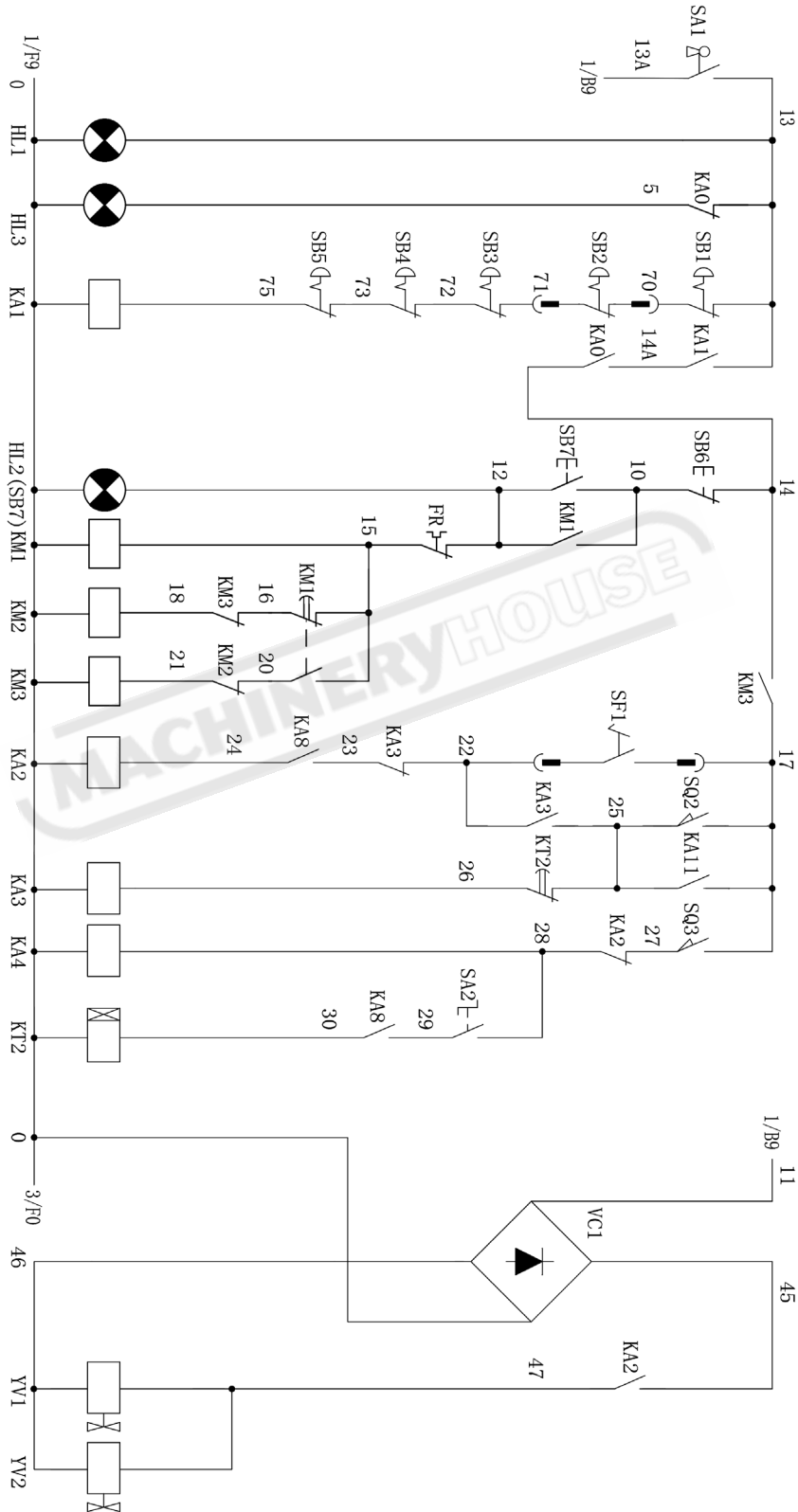

WIRING DIAGRAM FOR HG-3212, HG-4012 (PAGE 3)

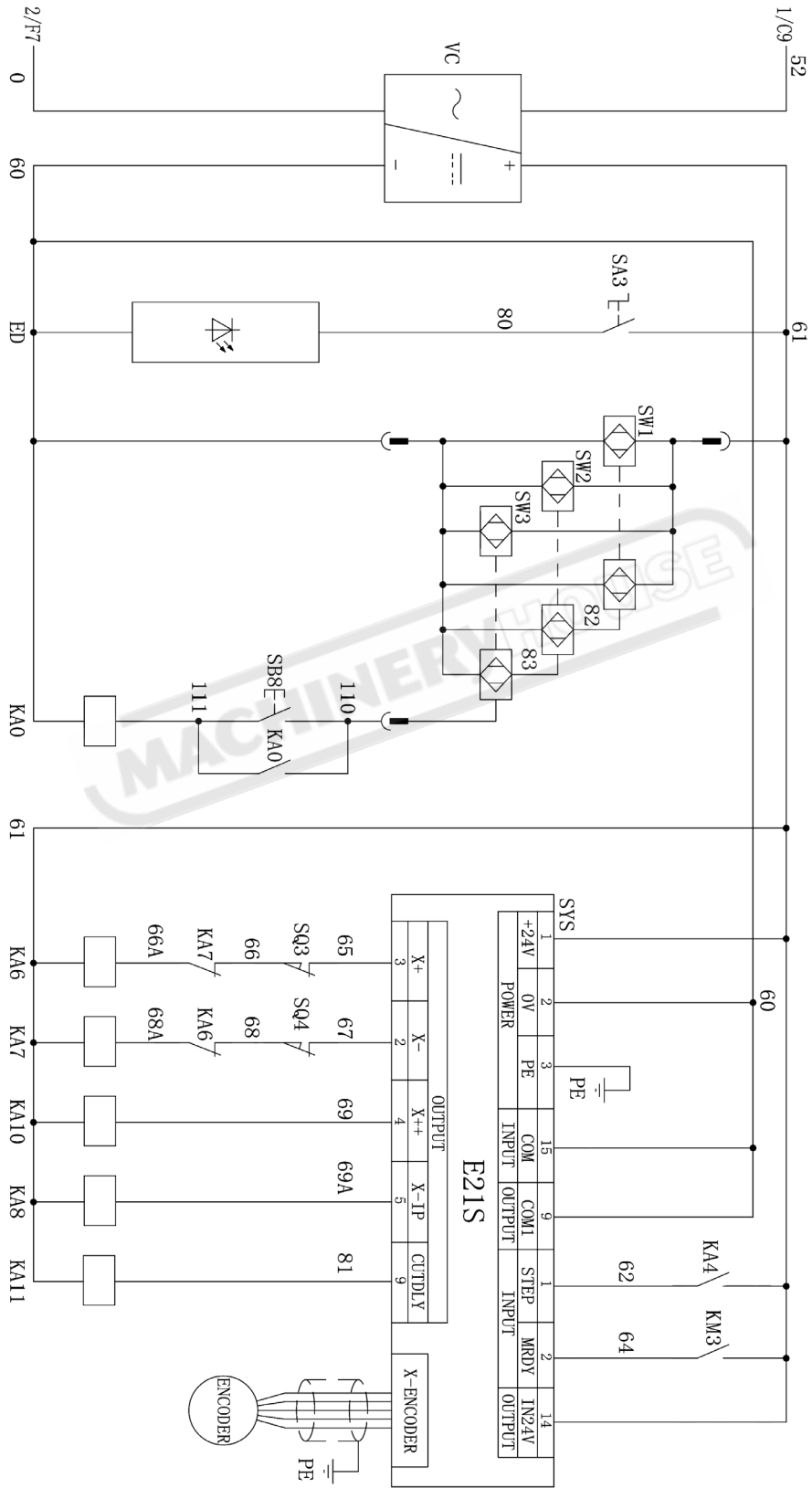

WARNING

General Machinery Safety Instructions

Machinery House
requires you to read this entire Manual before using this machine.

- 1. Read the entire Manual before starting machinery.** Machinery may cause serious injury if not correctly used.
- 2. Always use correct hearing protection when operating machinery.** Machinery noise may cause permanent hearing damage.
- 3. Machinery must never be used when tired, or under the influence of drugs or alcohol.** When running machinery you must be alert at all times.
- 4. Wear correct Clothing.** At all times remove all loose clothing, necklaces, rings, jewelry, etc. Long hair must be contained in a hair net. Non-slip protective footwear must be worn.
- 5. Always wear correct respirators around fumes or dust when operating machinery.** Machinery fumes & dust can cause serious respiratory illness. Dust extractors must be used where applicable.
- 6. Always wear correct safety glasses.** When machining you must use the correct eye protection to prevent injuring your eyes.
- 7. Keep work clean and make sure you have good lighting.** Cluttered and dark shadows may cause accidents.
- 8. Personnel must be properly trained or well supervised when operating machinery.** Make sure you have clear and safe understanding of the machine you are operating.
- 9. Keep children and visitors away.** Make sure children and visitors are at a safe distance for you work area.
- 10. Keep your workshop childproof.** Use padlocks, Turn off master power switches and remove start switch keys.
- 11. Never leave machine unattended.** Turn power off and wait till machine has come to a complete stop before leaving the machine unattended.
- 12. Make a safe working environment.** Do not use machine in a damp, wet area, or where flammable or noxious fumes may exist.
- 13. Disconnect main power before service machine.** Make sure power switch is in the off position before re-connecting.
- 14. Use correct amperage extension cords.** Undersized extension cords overheat and lose power. Replace extension cords if they become damaged.
- 15. Keep machine well maintained.** Keep blades sharp and clean for best and safest performance. Follow instructions when lubricating and changing accessories.
- 16. Keep machine well guarded.** Make sure guards on machine are in place and are all working correctly.
- 17. Do not overreach.** Keep proper footing and balance at all times.
- 18. Secure workpiece.** Use clamps or a vice to hold the workpiece where practical. Keeping the workpiece secure will free up your hand to operate the machine and will protect hand from injury.
- 19. Check machine over before operating.** Check machine for damaged parts, loose bolts, Keys and wrenches left on machine and any other conditions that may effect the machines operation. Repair and replace damaged parts.
- 20. Use recommended accessories.** Refer to instruction manual or ask correct service officer when using accessories. The use of improper accessories may cause the risk of injury.
- 21. Do not force machinery.** Work at the speed and capacity at which the machine or accessory was designed.
- 22. Use correct lifting practice.** Always use the correct lifting methods when using machinery. Incorrect lifting methods can cause serious injury.
- 23. Lock mobile bases.** Make sure any mobile bases are locked before using machine.
- 24. Allergic reactions.** Certain metal shavings and cutting fluids may cause an allergic reaction in people and animals, especially when cutting as the fumes can be inhaled. Make sure you know what type of metal and cutting fluid you will be exposed to and how to avoid contamination.
- 25. Call for help.** If at any time you experience difficulties, stop the machine and call you nearest branch service department for help.

WARNING

Power Operated Guillotine Safety Instructions

Machinery House
requires you to read this entire Manual before using this machine.

- 1. Maintenance.** Make sure the Guillotine is turned off and disconnect from the main power supply and make sure all moving parts have come to a complete stop before any inspection, adjustment or maintenance is carried out.
- 2. Guillotine Condition.** Guillotine must be maintained for a proper working condition. Never operate a Guillotine that has low oil levels, damaged or worn parts. Scheduled routine maintenance should be performed on a scheduled basis.
- 3. Blade Condition.** Never operate a Guillotine with a damaged or badly worn blades. Replace if required.
- 4. Pump Direction.** Pump rotation must be in arrow direction otherwise the pump will be damaged.
- 5. Hand Hazard.** Keep hands and fingers clear from moving parts. Serious injury can occur if hand or finger tips come between blades.
- 6. Personal Protection.** Gloves are recommended when handling the workpieces.
- 7. Authorized and trained personnel.** The machine must be operated by authorized and trained personnel. The shear is designed to be operated by a single user. Using the machine with more than one operator is forbidden, except for certain maintenance situations.
- 8. Power outage.** In the event of a power failure during use of the machine, turn off all switches to avoid possible sudden start up once power is restored.
- 9. Work area hazards.** Keep the area around the Guillotine clean from oil, tools, objects & chips. Pay attention to other persons in the area and know what is going on around the area to ensure unintended accidents.
- 10. Guards.** Operate machine only with all protective devices and guarding in place and operational. Never remove, defeat or bypass. Any presence-sensing safeguarding used must have regular Safety integrity tests and records kept. These records must be kept for 5 years or for the life of the plant and be handed to any person that you relinquish control of the plant to. Tests include stop time measurements, safety distance calculations and inspections, with operator checks and periodic maintenance checks. (WHS Regulation 226)
- 11. Material.** Material must NOT be hardened ceramic or glass-originated, non flat metals (at origin) e.g. rods, bars, tubes & pipes.
- 12. Blade gap adjustment.** Do NOT operate the machine without proper blade gap adjustment according to sheet thickness.
- 13. Warning Labels.** Take note of any warning labels on the machine and do not remove them.
- 14. Backgauge Area.** Do not access the backgauge area, while the machine is working.
- 15. Protective fence.** Do not bridge the safety limit switch of the rear protective fence.
- 16. Squaring arm.** Do not use side squaring arm and front support arms for intermediate storage of workpieces.
- 17. Operation.** During the shearing process, the workpiece may slide or move unexpectedly. Therefore, the material must be handled carefully.
- 18. Emergency stop.** Use the emergency stop button in case of any emergency.
- 19. Level machine.** Level the machine on a flat concrete surface by using a spirit level.
- 20. Overloading machine.** Do not exceed the rated capacity of the guillotine. Please refer to the manual for capacities.
- 21. Hearing protection and hazards.** Always wear hearing protection as noise generated from machine and workpiece can cause permanent hearing loss over time.
- 22. Call for help.** If at any time you experience difficulties, stop the machine and call your nearest branch service department for help.

PLANT SAFETY PROGRAM

NEW MACHINERY HAZARD IDENTIFICATION, ASSESSMENT & CONTROL

Power Operated Guillotine

Developed in Co-operation Between A.W.I.S.A and Australia Chamber of Manufactures
This program is based upon the Safe Work Australia, Code of Practice - Managing Risks of Plant in the Workplace (WHSA 2011 No10)

Item No.	Hazard Identification	Hazard Assessment	Risk Control Strategies <small>(Recommended for Purchase / Buyer / User)</small>
B	CRUSHING	LOW	Secure & support work material on table.
C	CUTTING, STABBING, PUNCTURING	MEDIUM	Wear gloves to prevent cuts from sharp material offcuts.
D	SHEARING	MEDIUM	Hands should be kept clear of moving parts and blades. Isolate power to machine prior to any checks or maintenance. Ensure front blade guard is fitted securely. Do not adjust or clean until machine has fully stopped. Access to the rear of machine must be interlock or photoelectric guarded to prevent access when the machine is operating, (see workover authority principles of machine guarding for guidelines).
F	STRIKING	MEDIUM	Wear safety glasses. Stand clear of falling offcuts. Ensure material hold downs are correctly adjusted. Ensure guards are secured properly.
H	ELECTRICAL	MEDIUM	Machine should be installed & checked by a Licensed Electrician. All electrical enclosures should only be opened with a tool that is not to be kept with the machine.
O	OTHER HAZARDS, NOISE.	LOW	Wear hearing protection as required.
Plant Safety Program to be read in conjunction with manufactures instructions			



www.machineryhouse.com.au



www.machineryhouse.co.nz

Authorised and signed by:
Safety officer:
Manager: 

Revised Date: 25th Sept 2015

E21S Operation Manual

(Version: V1.05)



ESTUN AUTOMATION CO., LTD

— Total Solution Supplier

Contents

Preface	1
Chapter 1 Product Overview	2
1.1 Product introduction	2
1.2 Operation panel	2
1.3 Displayer	4
Chapter 2 Operation Instruction	5
2.1 Basic operation procedure	5
2.2 Programming	6
2.2.1 Single-step programming	6
2.2.2 Multi-step programming.....	8
2.3 Parameter setting.....	11
2.4 Manual movement	14
Chapter 3 Alarm	15
Appendix Common fault and troubleshooting.....	17

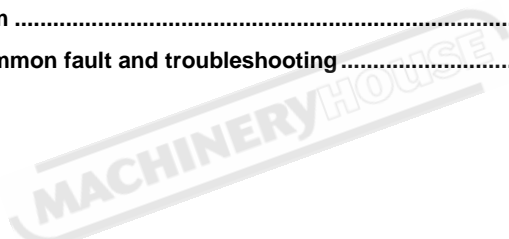

Preface

This manual describes operation of E21S numerical control device and is meant for operators who are instructed for operation of the device. Operator shall read this manual and know operation requirements before using this device.

Copy right is preserved by ESTUN. It is not allowed to add or delete part or all of the manual content without ESTUN's consent. Do not use part or all of manual content for the third party's design.

E21S device provides complete software control and has no mechanical protection device for operator or the tool machine. Therefore, in case of malfunction, machine tool must provide protection device for operator and external part of the machine tool. ESTUN is not responsible for any direct or indirect losses caused by normal or abnormal operation of the device.

ESTUN preserves the right to modifying this manual in the event of function adding or print error.



Chapter 1 Product Overview

1.1 Product introduction

This product is equipped with the shear machine dedicated numerical control device which is applicable to various users. Based on ensuring work precision, the cost of numerical control shearing machine is reduced significantly.

Features and functions of this product are as following:

- Back gauge can be controlled.
- Cut-angle can be controlled.
- Cut-gap can be controlled.
- Stroke time can be controlled.
- Intelligent positioning control.
- Unilateral and bidirectional positioning which eliminates spindle clearance effectively.
- Retract functions.
- Automatic reference searching.
- One-key parameter backup and restore.
- Fast position indexing.
- 40 programs storage space, each program has 25 steps.
- Power-off protection.

1.2 Operation panel



















Operation panel is shown in Figure 1-1.



Figure 1-1 Operation panel

Functions of panel keys are described in Table 1-1.

Table 1-1 Description of key functions

Key	Function description
	Delete key: delete all data in input area on left bottom of displayer.
	Enter key: confirm the input content. If no content is input, the key has the similar function to direction key  .
	Start key: automatic start-up, top left corner of the key is operation indicator LED. When operation is started, this indicator LED is on.
	Stop key: stop operation, top left corner of the key is Stop indicator LED. When initialize normal start-up and no operation, this indicator LED is on.
	Left direction key: page forward, cursor remove
	Right direction key: page backward, cursor remove
	Down direction key: select parameter downward
	Function switch: switch over different function pages
	Symbolic key: user input symbol, or start diagnosis.
 ~ 	Numeric key: when setting parameter, input value.
	Decimal point key: when set up parameter, input decimal point.
	Manual movement key: in case of manual adjustment, make adjustment object move in forward direction at low speed.
	Manual movement key: in case of manual adjustment, make adjustment object move in backward direction at low speed.
	High speed selection key: in case of manual adjustment, press this key and press  simultaneously, make adjustment object move in increasing direction at high speed, then press  , make adjustment object move in decreasing direction at high speed.

1.3 Displayer

E21S numerical control device adopts 160*160 dot matrix LCD displayer. The display area is shown in **Figure 1-2**.

Single	
X:	200.00
A: 50.00	G: 9.98
XP:	20.00
DX: 2	F: 0
CUT: 3.00	PP: 0
DLY: 1.00	CP: 14
✎ Range: 0~9999.999mm	

Figure 1-2 Display area

- Title bar: display relevant information of current page, such as its name, etc.
- Parameter display area: display parameter name, parameter value and system information.
- Status bar: display area of input information and prompt message, etc.

The paraphrases of shortening on this page are as shown in Table 1-2.

Table 1-2 The paraphrases of shortening

Shortening	Description
X	The current backgauge position
A	The current cutting angle
G	The current gap distance
XP	The desired backgauge position
DX	Backgauge retract distance
CUT	Cutting delay
DLY	Retracting delay
F	Function output value
PP	Preset workpiece
CP	Current workpiece

Chapter 2 Operation Instruction

2.1 Basic operation procedure

Basic switch over and operation procedure of the device is shown in **Figure 2-1**.

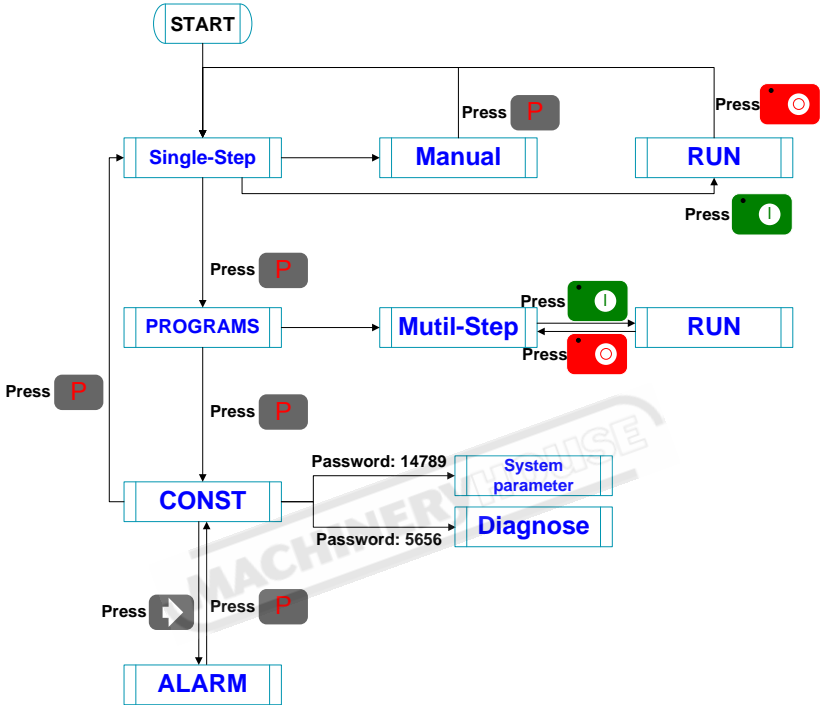

Figure 2-1 Basic Operational Flow

2.2 Programming

The device has two programming methods, which are single-step programming and multi-step programming. User can set up programming according to actual demand.

2.2.1 Single-step programming



Single-step programming is generally used for processing single step to finish work piece processing. When controller is power on, it will automatically enter single-step program page.

Operation steps

Step 1 After starting up, the device will enter setting up page of single-step program automatically, as shown in **Figure 2-2**.

Single	
X:	200.00
A: 50.00	G: 9.98
XP:	20.00
DX: 2	F: 0
CUT: 3.00	PP: 0
DLY: 1.00	CP: 14
✎ Range: 0~9999.999mm	

Figure 2-2 Single-step program setting page

Step 2 Click , select parameter that needs to be set up, press numerical key to input program value, press  to complete input.

[Note] Parameter can only be set when Stop indicator is on.

Setting range of single step parameter is shown in Table 2-1.

Table 2-1 Set up range of single step parameter

Parameter name	Unit	Range	Remarks
X	mm/inch	-	Current position of X axis, unable to be modified.
A	°	-	Current position of A axis, unable to be modified.
G	mm/inch	-	Current position of G axis, unable to be modified.
XP	mm/inch	0~9999.999	Program position of X axle.
DX	mm/inch	0~9999.999	Retract distance of X axle;

Parameter name	Unit	Range	Remarks
DLY	s	0~9.99	In case of single step, delay time for X axle concession.
CUT	s	0~9.99	There is a delay time for the cutter goes to the next work-step, after it leaves the top dead center. [Note] Only the parameter CutDelay En. is set to 1, displaying this parameter.
F	None	0~3	Functions configure output.
PP	None	0~9999	Number of preset work piece.
CP	None	0~9999	Number of current work piece.

Step 3 Press , system will execute according to this program, as shown in **Figure 2-3**.

Single		
X:	200.0	
A:	3.0	
G:	9.99	
C:	0	
PP:	0	metric

Figure 2-3 Single step operation page



---End



Operation example

On single-step program page, program back gauge position to 80.00mm, retract distance to 50mm, concession waiting time to 2s, and work piece to 10.

Operation steps are shown in Table 2-2.

Table 2-2 Operation steps of single step example

Operation steps	Operation
Step 1	Click  , select "XP" parameter.
Step 2	Input 80.00 by numerical key.
Step 3	Click  , confirm setting of this parameter.

Operation steps	Operation
Step 4	Click  , select "DX" parameter, "DLY" parameter, "PP" parameter respectively.
Step 5	Set up parameter to 50mm, 2s, 10 by numerical key.
Step 6	Click  , system execute according to this program.

2.2.2 Multi-step programming

Multi-step program is used for processing single work piece of different processing steps, realize consecutive implementation of multi-steps, and improve processing efficiency.

Operation step

Step 1 Power on, the device enters to single-step parameter set up page automatically.

Step 2 Click , switch to program manage page, as shown in Figure 2-4.

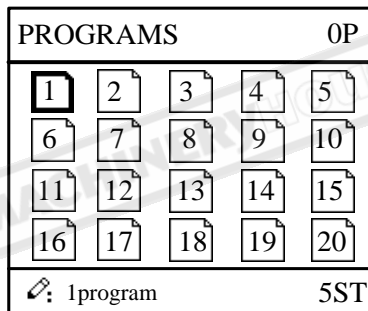





Figure 2-4 Program management page

Step 3 Click , , , select program serial number, or input program number directly, such as input "1".

Step 4 Click , enter multi-step program setting page, as shown in Figure 2-5.

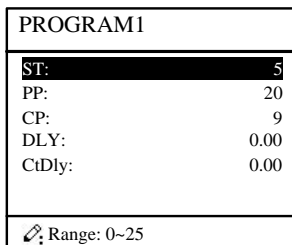







Figure 2-5 Multi-step program setting page





Step 5 Click , select multi-step programming parameter which requires set up, input setting up value, click , and the configuration takes effect.

Step 6 In completion of set up, click , enter step parameter set page, as shown in **Figure 2-6**.

PROGRAM1	1/ 5ST
X:	50.00
XP:	9.000
DX:	25.00
RP:	54
F:	1
✎ Range: 0~9999.999mm	

Figure 2-6 Step parameter set page

Step 7 Click , select step parameter that needs to be set up, input program value, click , and the setup takes effect.

Step 8 Click   to switch over between steps. If the current step is the first step, click  to enter the last page of step parameter setting; if the current step is the last one, click  to enter the first page of step parameter setting.

Multi-step parameter setting range is shown in Table 2-3.

Table 2-3 Multi-step parameter setting range

Parameter name	Unit	Range	Remarks
ST	None	0-25	Set up total processing step number of this program
PP	None	0~99999	Number of work piece to be processed, decreasing piece when more than zero; negative increasing count.
CP	None	0~99999	Number of finished work piece
DLY	s	0~9.99	Time between retract signal and concession execution.

Parameter name	Unit	Range	Remarks
CtDly	s	0~9.99	There is a delay time for the cutter goes to the next work-step, after it leaves the top dead center. [Note] Only the parameter CutDelay En. is set to 1, displaying this parameter.
X	mm/inch	None	Current position of X axle, can't be modified.
XP	mm/inch	0~9999.999	Program position of X axle.
DX	mm/inch	0~9999.999	Distance of X axle concession.
RP	-	1~99	Repeat times required by this step.
F	-	0~3	F function configure output

Step 9 Click , system will operate according to this program, as shown in **Figure 2-7**.

PROGRAM1	Rp: 1/54
X:	200.0
A:	3.0
G:	9.99
C:	0
PP: 12345	St: 1/ 5

Figure 2-7 Multi-step programming operation page

---End

Operation example

[Background] One work piece requires processing 50 as shown below;

- First shear: 50mm;
- Second shear: 100mm;
- Third shear: 300mm;











[Analysis] according to work piece and technological conditions of machine tool:

- First shear: X axle position is 50.0mm, concession 50mm;
- The second shear: X axle position is 100.0mm, concession 50mm;
- The third shear: X axle position is 300.0mm, concession 50mm;

Edit processing program of this work piece on No. 2 program.

Operation procedure is shown in Table 2-4.

Table 2-4 Operation steps of multi-step programming example

Operation step	Operation
Step 1	On single step parameter setting page, press  to enter program selection page.
Step 2	Input "2", click  , enter multi-step general parameter setting page of program 2.
Step 3	Select "Program step", input "3", click  , the setting takes effect.
Step 4	Select "PP", input "50", click  , the setup takes effect.
Step 5	Similar to step 3 and step 4, set "DLY" to 3 respectively.
Step 6	Click  , to enter first step setup page of step parameter.
Step 7	Select "XP", input 50, click  , the setup takes effect.
Step 8	Similar to step 7, set up "concession distance" and "repeat times" to 50, 1 respectively.
Step 9	Click  , to enter second step setup page of step parameter, the setup method is similar to that of step one.
Step 10	Click  , again, to enter third step setup page of step parameter, the setup method is similar to that of step one and step two.
Step11	Click  , return to setup page of the first step.
Step12	Click  , system will operate according to this program.

[Note]

- In completion of multi-step programming, you should back to starting step before launching the system; otherwise, the program will start position processing at current step.
- Press left and right direction key to circulate page turning and browsing among all step parameters.
- Program can be called and revised again.
- In completion of processing all work pieces (50 in the example), the system stops automatically. Restart directly will start another round of processing 50 work pieces.

2.3 Parameter setting

User can setup all parameters required for normal operation of the system, including system parameter, X axle parameter.

Step 1 On program management page, click  to enter programming constant page, as shown in **Figure 2-8**. On this page, programming constant can be set.

CONST	
mm/inch:	0
中文/English:	0
Pulse Time:	0.020
Version:	V1.10
✎:0:mm 1:inch	

Figure 2-8 Programming constant page

Range of programming constant setup is shown in Table 2-5.

Table 2-5 Range of programming constant setup

Parameter name	Unit	Range	Default	Remarks
X-tea. in	mm	0-9999.99	0	Input current X axle position when teach enable.
mm/inch	-	0 or 1	0	<ul style="list-style-type: none"> • 0: mm • 1: inch
中文/English	-	0 or 1	0	<ul style="list-style-type: none"> • 0: 中文 • 1: English
X-tea. In	mm	0~9999.999	10	Input current X axle position when teach enable.
G-tea. In	mm	0~9.99	0	Input current G axle position when teach enable.
Pulse Time	s	0.000~1.000	0.020	The duration of the pulse signal.
Version	-	None	-	Software version information, V refers to version, 1 indicates version number, and 0 indicates version level.

Step 2 Input password "1212", click  to enter system parameter setting page, as shown in **Figure 2-9**.

SYS PARA		1/ 2PG
X-digits:		3
X-safe:	1.000	
Step delay:	3.33	
CutDelay En.:	1	
MaxCut Delay:	9.99	
X-tea.in:	200	
G-tea.in:	5	
✎ Range: 0~3		

Figure 2-9 System parameter setting page

Step 3 Step up parameter, parameter setup range is shown in **Table 2-6**.

Table 2-6 System parameter description



Parameter	Unit	Range	Default	Description
X-digits	-	0-3	1	Decimal point displayed by X axle position parameter
X-safe	mm	0-9999.999	10	X axle keeps low speed in this range
Step delay	s	0-9.99	0.5	Interval between valid change step signal and change step operation executed
CutDelay En.	-	0 or 1	0	<ul style="list-style-type: none"> • 0: disable • 1: enable
MaxCut Delay	s	0~9.99	0	Set the maximum cut delay time.
A-Enable	-	0 or 1	1	<ul style="list-style-type: none"> • 0: disable • 1: enable
A-Max	°	2.50 or 3.00	3.00	The max value of the Cut-Angle.
G-Enable	-	0 or 1	1	<ul style="list-style-type: none"> • 0: disable • 1: enable
G-Encoder Dir.	-	0 or 1	0	<ul style="list-style-type: none"> • 0: Decrease • 1: Increase
GMF	-	1~99999999	40	Multiplication factor of G-axis, used for the convert between pulses and mm.
GDF	-	1~99999999	1	Division factor of G-axis, used for the convert between pulses and mm.

Step 4 Click , return to programming constant page.

---End







2.4 Manual movement

In single-step mode, axle movement can be controlled by pressing key manually. This method helps user to adjust machine tool and work piece.

Step 1 On single step parameter setup page, click ,  or  to enter manual page, as shown in **Figure 2-10**.

MANUAL	
X:	50.00
A:	0.00
G:	9.98
✎ X current pos.	

Figure 2-10 Manual page

Step 2 Click , operate at low speed in increasing direction.
 Click , operate at low speed in decreasing direction.
 Click  , click  at the same time, and operate at high speed in increasing direction (this operation is valid only when using frequency converter as the drive).
 Click  , click  at the same time, and operate at high speed in decreasing direction (this operation is valid only when using frequency converter as the drive).

Step 3 Click  return to single step parameter setting page.

---End

Chapter 3 Alarm

The device can detect internal or external abnormality automatically and send out alarm prompt. Alarm message is available on alarm list.

Step 1 On programming management page, click  to enter programming constant page.

Step 2 On programming constant page, click  to enter "Alarm history" page to view all alarm history.

As shown in **Figure 3-1**, the latest 6 alarms, alarm number and causes can be viewed on this page.

ALARM RECORD	
A.24	Mach. Not ready

Figure 3-1 Alarm history page

Alarm history and message is shown in Table 3-1.

Table 3-1 Alarm number and alarm message

Alarm number	Alarm name	Alarm description
A.01	Pieces reached	Count reaches preset value
A.02	X.Pos < min.	X-axis current position beyond the minimum limit
A.03	X.Pos > max.	X-axis current position beyond the maximum limit
A.04	-	The current position of the X-axis beyond the soft limit
A.05	A Axis MAX	A-axis current position beyond the maximum limit
A.06	A Axis MIN	A-axis current position beyond the minimum limit
A.07	G Axis MAX	G-axis current position beyond the maximum limit
A.08	G Axis MIN	G-axis current position beyond the minimum limit

Alarm number	Alarm name	Alarm description
A.11	Finished work	When count reaches preset value, system shut down automatically.
A.12	Out of UDP	In single step and multistep mode, slider is not on upper dead center.
A.22	Encoder abnor.	Encoder voltage is too low
A.24	Mach. not ready	The pump signal is invalid
A.25	Angle Abnormal	Angle input error
A.26	X Stop Err	The backgauge motor is abnormal stop.
A.28	X V2 Err	The speed of backgauge motor is abnormal on the Low-Speed Mode.
A.29	X V3 Err	The speed of backgauge motor is abnormal on the High-Speed Mode.
A.32	XPos < 0	X-axis position has exceeded the zero point in manual mode, you should turn back.
A.41	Para. error	-
A.42	Power off	-
A.43	System fault	-

Appendix Common fault and troubleshooting

Fault phenomena	Trouble shooting
When power on, the device will not display.	<ul style="list-style-type: none"> • The electrode of power supply terminal is connected error; please see the information of power nameplate. • Voltage is too low. • Electrical outlet is not connected.
When X axle programming is operating, back gauge motor does not move, but Y AXIS motor moves.	Two motors are reversed. Reconnect.
When program is operating, motor does not move.	<ul style="list-style-type: none"> • Check whether mechanical part has been locked or slider returns to upper dead center. • Check whether the motor wiring is connected well.
Motor can't switch from high speed to low speed.	<ul style="list-style-type: none"> • Check whether high-low speed signal has been sent or motor power is too small. • Check whether the parameter of distance conversion is correct.
When system is in multi-step programming, the program can't change step.	Check when slider is on upper dead center, STEP terminal is connected to +24V or not.
When system is in multi-step programming, the program can't count.	Check when slider is on upper dead center, STEP terminal is connected to +24V or not.
When programming is operating, the device loses control.	<ul style="list-style-type: none"> • Check whether encoder cable is connected or not. • Check whether the motor-direction wiring is correct (X+, X-, A+, A-, G+, G-).
When programming is operating, system actual position will not display or change.	Check whether encoder wiring is correct or encoder cable is connected well.